

(19) World Intellectual Property
Organization
International Bureau



(43) International Publication Date
23 December 2004 (23.12.2004)

PCT

(10) International Publication Number
WO 2004/112117 A1

(51) International Patent Classification?: **H01L 21/306**,
B01D 53/00, 53/72

Drive, Santee, CA 92071 (US). **TRAM, Allan** [US/US];
7745 Prairie Shadow Road, San Diego, CA 92126 (US).

(21) International Application Number:
PCT/US2004/017251

(74) Agents: **CARROLL, Alice, O.** et al.; Hamilton, Brook,
Smith & Reynolds, P.C., 530 Virginia Road, P.O. Box 9133,
Concord, MA 01742-9133 (US).

(22) International Filing Date: 1 June 2004 (01.06.2004)

(81) Designated States (*unless otherwise indicated, for every
kind of national protection available*): AE, AG, AL, AM,
AT, AU, AZ, BA, BB, BG, BR, BW, BY, BZ, CA, CH, CN,
CO, CR, CU, CZ, DE, DK, DM, DZ, EC, EE, EG, ES, FI,
GB, GD, GE, GH, GM, HR, HU, ID, IL, IN, IS, JP, KE,
KG, KP, KR, KZ, LC, LK, LR, LS, LT, LU, LV, MA, MD,
MG, MK, MN, MW, MX, MZ, NA, NI, NO, NZ, OM, PG,
PH, PL, PT, RO, RU, SC, SD, SE, SG, SK, SL, SY, TJ, TM,
TN, TR, TT, TZ, UA, UG, UZ, VC, VN, YU, ZA, ZM, ZW.

(25) Filing Language: English

(26) Publication Language: English

(30) Priority Data:
60/475,145 2 June 2003 (02.06.2003) US
10/683,903 10 October 2003 (10.10.2003) US
10/683,904 10 October 2003 (10.10.2003) US

(84) Designated States (*unless otherwise indicated, for every
kind of regional protection available*): ARIPO (BW, GH,
GM, KE, LS, MW, MZ, NA, SD, SL, SZ, TZ, UG, ZM,
ZW), Eurasian (AM, AZ, BY, KG, KZ, MD, RU, TJ, TM),
European (AT, BE, BG, CH, CY, CZ, DE, DK, EE, ES, FI,
FR, GB, GR, HU, IE, IT, LU, MC, NL, PL, PT, RO, SE, SI,
SK, TR), OAPI (BF, BJ, CF, CG, CI, CM, GA, GN, GQ,
GW, ML, MR, NE, SN, TD, TG).

(63) Related by continuation (CON) or continuation-in-part
(CIP) to earlier applications:
US 10/683,903 (CIP)
Filed on 10 October 2003 (10.10.2003)
US 10/683,904 (CIP)
Filed on 10 October 2003 (10.10.2003)

(71) Applicant (*for all designated States except US*): **MYKRO-
LIS CORPORATION** [US/US]; 129 Concord Road, Bil-
lerica, MA 01821 (US).

Published:
— *with international search report*
— *before the expiration of the time limit for amending the
claims and to be republished in the event of receipt of
amendments*

(72) Inventors; and
(75) Inventors/Applicants (*for US only*): **SPIEGELMAN,
Jeffrey, J.** [US/US]; 5389 Meadows Del Mar, San Diego,
CA 92130 (US). **ALVAREZ, Daniel, J., Jr.** [US/US];
10908 Black Mountain Road #1, San Diego, CA 92126
(US). **HOLMES, Russell, J.** [US/US]; 8437 Rumson

*For two-letter codes and other abbreviations, refer to the "Guid-
ance Notes on Codes and Abbreviations" appearing at the begin-
ning of each regular issue of the PCT Gazette.*

WO 2004/112117 A1

(54) Title: METHOD FOR THE REMOVAL OF AIRBORNE MOLECULAR CONTAMINANTS USING OXYGEN AND/OR
WATER GAS MIXTURES

(57) Abstract: The present invention discloses a method for the removal of a number of molecular contaminants from surfaces within a device. A purge gas containing oxygen and/or water is introduced into the interior of the device, contacting at least a portion of the interior surfaces. A contaminated purge gas is produced by transferring a portion of the contamination from the interior surfaces into the purge gas. The contaminated purge gas is removed from the device and the process is continued until the contaminant concentration in the contaminated purge gas is below a predetermined level.

METHOD FOR THE REMOVAL OF AIRBORNE MOLECULAR
CONTAMINANTS USING OXYGEN AND/OR WATER GAS MIXTURES

5 RELATED APPLICATIONS

This application is a continuation-in-part of U.S. Application No. 10/683,903, filed October 10, 2003, which claims the benefit of U.S. Provisional Application No. 60/475,145, filed on June 2, 2003. This application is also a continuation-in-part of U.S. Application No. 10/683,904, filed October 10, 2003, which claims the benefit of U.S. Provisional Application No. 60/475,145, filed on June 2, 2003. The entire teachings of the above applications are incorporated herein by reference.

BACKGROUND OF THE INVENTION

15 In the manufacture of high purity products, such as silicon wafers, intended for semiconductor substrates or in the photolithography steps of manufacture of semiconductors, it is necessary to maintain a high degree of cleanliness. The products themselves must be clean, the atmospheres surrounding them throughout the manufacturing process must be clean, and the steps and equipment used in the manufacture must not impair cleanliness. It is well known that with the minute sizes of circuitry and components incorporated into semiconductor chips, even extremely small contaminant particles when deposited on chip surfaces are destructive to the chips. It is common for loss rates of wafers and chips during manufacturing to be a significant portion of the total production due to system contamination.

25 Manufacturers of wafers and chips have been engaged in extensive and continual efforts to improve on the cleanliness of their fabrication facilities ("fabs") including efforts to have manufacturing and process materials and gases of high purity. Such efforts have been generally successful in the past, in that gases with purities defined by contaminant levels in the parts per million (ppm) and even into 30 the parts per billion (ppb) ranges have been achieved. Generally improvements in

process system cleanliness have paralleled increases in the component density of chips and reductions in the size of chip components and circuitry.

However, the ability of the prior art to achieve such parallel improvements in gases has more recently been severely taxed as the size of chip components has continued to decrease and component density has continued to increase. With the movement to 198 nm and 157 nm semiconductor technologies, the ability of the products to tolerate contamination has substantially decreased, and process gases that previously were of adequate purities are no longer suitable. Scale-up techniques that previously achieved adequate improvements in the purity of such gases have been found to be ineffective in these "ultra high purity" (UHP) systems in which the lower nm level technologies are produced. Further, at the lower IC dimensions materials that were previously considered minor contaminants have been found to act as major contaminants, and the prior art gases have been found to be ineffective in removing such contaminant materials.

Ultrahigh purity products and process tools are susceptible to airborne molecular contaminants (AMCs) that can reduce product quality and yield. AMCs generally include, but are not limited to SO_x , NO_x , siloxanes, organophosphorus compounds, ammonia, moisture, oxygen and hydrocarbons (> 4 carbons). For purposes of the present invention, oxygen and moisture are not considered to be AMCs.

In the production of wafers for the semiconductor industry, there are three major sources of contamination, wafer storage containers (for example, Front-Opening Unified Pods or FOUPs) themselves; clean room air that enters the container as the wafers are moved between tools and the wafers themselves that may leech contaminants during the various manufacturing processes. Methods have been developed to sufficiently reduce water and oxygen contamination in the manufacturing process. Additionally, methods have been developed for the removal of reaction products of the wafer with water and oxygen (*e.g.*, silicon oxides) that can form on the surface of the wafers. However, technologies have not developed for the efficient removal of a number of airborne contaminants and their resulting reaction products on wafers.

Various contaminants have different effects. For example, in photolithography simple hydrocarbons can condense on the lens assembly and result in transmission loss. Heavy hydrocarbons and significant concentrations of light hydrocarbons irreversibly deposit on optical surfaces and become graphitized by ultraviolet (UV) exposure. In a similar manner, silicon-containing organics, *e.g.*, siloxanes, react under UV irradiation to produce SiO₂ crystallites that refract and absorb the incident light. Other AMCs, *e.g.*, NO_x and SO_x, typically wherein $0 < x \leq 3$, cause optical hazing. Basic AMCs, *e.g.*, amines, quench the photoacids, in addition to causing optical hazing. In the context of photolithography, oxygen and water can be detrimental to the production process and are typically considered to be AMCs in the prior art. Recently, it has been reported by Veillerot *et al.*, (*Solid State Phenomena* Vol. 92, 2003, pp. 105-108) that atmospheric hydrocarbon contamination has a detrimental impact on 4.5 nm gate oxide integrity when wafers are stored in a continuous flow of purge gas between gas oxide and polysilicon deposition steps.

Approaches being tried to reduce this contamination include large-scale chemical filtration of the cleanroom air, moving from open to closed cassettes, and nitrogen purging of wafers during storage and transport. Nitrogen purging of UHP components such as valves and gas delivery piping, has been practiced for many years, and can be effective in removing oxygen and water. However, large scale use of nitrogen for purging large volume IC process equipment and large numbers of cassettes can be expensive and present a serious asphyxiation hazard. Additionally, it is suspected that nitrogen purging of hydrocarbon contaminated surfaces is not completely effective in removing the hydrocarbons.

Methods for analysis of contaminants in gas streams are well known. FIG. 1 (Prior Art) is a schematic flow diagram of a double dilution system 100 coupled to a gas chromatograph gas analysis system 120. The double dilution system 100 comprising mass flow controllers 106, 108, 110, and 112 enables the precise dilution of a gas standard 114 with a carrier gas 102 over a range of six orders of magnitude (10⁶). Commonly available gas standards in the part per million range can be effectively diluted to the part per trillion (ppt) range with system 100. The dilution system 100 can be coupled to a gas chromatograph system 120 for the purposes of

calibrating the response of the chromatograph 126, by connecting the output 116 of the dilution system to the input 122 of the chromatographic gas analysis system 120. A cold trap 124 accumulates condensed hydrocarbons in the sample, prior to injection into the gas chromatograph 126. In this manner, the effective sensitivity of the chromatograph can be increased and ppt level hydrocarbon concentrations reliably measured.

FIG. 2 (Prior Art) is a calibration graph 200 of signal response area 204 versus sample hydrocarbon concentration 202 for various hydrocarbon molecules including benzene 206, toluene 208, ethyl-benzene 210, *meta,para*-xylene 212, *ortho*-xylene 214, a second toluene 216, for the analysis system 120 coupled to dilution system 100. The data 220 show a linear response relationship between the peak area 204 and concentration 202 over almost six orders of magnitude, with a minimum sensitivity of 1 ppt.

FIG. 3 (Prior Art) is a graph 300 of time 302 versus gas chromatograph 126 detector signal 304 for a sample containing 1 ppt each of benzene, toluene, ethyl-benzene, and xylene. Here it can be seen that 1ppt level concentrations for each of the hydrocarbons in the mixture result in clearly distinguished peaks for benzene 306, toluene 308, ethyl-benzene 310, and xylene 312.

20 SUMMARY OF THE INVENTION

The present invention is generally directed to a method for removing airborne molecular contaminants (AMC) from a surface comprising contacting at least a portion of the surface and the area surrounding the surface with a purified purge gas, where the purge gas comprises oxygen, water or a combination thereof, and the purified purge gas has an AMC concentration less than about 1 part per billion (ppb) on a volume basis; producing a contaminated purge gas by transferring a portion of the contaminants from the surface into the purified purge gas; and removing the contaminated purge gas from the surface.

It is an object of the present invention to provide a method for the removal of airborne molecular contaminants (AMCs) from surfaces, generally within a device. In one embodiment, the method comprises introducing a purge gas containing oxygen and preferably having an AMC concentration of less than 1 part per billion

on a volume basis into an interior portion of the device, contacting at least a portion of the surfaces with the purge gas, producing a contaminated purge gas by transferring a portion of the molecular contaminants from the surfaces into the purge gas, and removing the contaminated purge gas from the device. The preceding steps
5 are typically continued or repeated until the contaminant concentration in the contaminated purge gas is decreased to a desired level, preferably below 1 part per billion on a volume basis, more preferably below 100 ppt contaminant on a volume basis. Additionally, the oxygen containing purge gas may further include moisture (*i.e.*, water).

10 In a further embodiment of the present invention, the method comprises purifying a purge gas containing oxygen at a concentration between 1 and 25 volume %, also preferably having a molecular contaminant concentration of less than 1 ppb, introducing the purified purge gas into an interior portion of the device, contacting at least a portion of the surfaces with the purified purge gas, producing a
15 contaminated purge gas by transferring a portion of the molecular contaminants from the surfaces into the purified purge gas, and removing the contaminated purge gas from said device. The method typically further comprises continuing the preceding steps until a contaminant concentration in the contaminated purge gas is decreased to a desired level, preferably below about 1 ppb, more preferably below
20 about 100 ppt. Additionally, the oxygen containing purge gas may contain water at a concentration between about 100 ppm to about 2 volume %.

In a third embodiment of the present invention, the method comprises purifying a purge gas containing water (*e.g.*, at a concentration between about 100 ppm and about 2 volume % moisture) with the overall mixture having a molecular
25 contaminant concentration of less than 1 ppb, introducing the purified purge gas into an interior portion of the device, contacting at least a portion of the surfaces with the purified purge gas, producing a contaminated purge gas by transferring a portion of the molecular contaminants from the surfaces into the purified purge gas, and removing the purified purge gas from said device. The method typically further
30 comprises continuing the preceding steps until the contaminant concentration in the contaminated purge gas is decreased to a desired level, preferably below about 1 ppb contaminant on a volume basis, more preferably below about 100 ppt contaminant.

The methods disclosed herein are particularly useful for removing contaminants from surfaces such as the interior surface of an ultrahigh purity gas line and the interior surface of valves present in a gas line, along with the interior surface of stainless steel chambers (e.g., chambers used for manufacturing silicon wafers).

BRIEF DESCRIPTION OF THE DRAWINGS

- FIG. 1 is a schematic flow diagram of a double dilution manifold coupled to a gas chromatograph gas analysis system.
- 10 FIG. 2 is a calibration graph for the apparatus of FIG. 1 showing signal response area versus sample hydrocarbon concentration for various hydrocarbon molecules.
- FIG. 3 is a graph of gas chromatograph detector signal versus time for a sample containing 1 ppt each of various hydrocarbon components.
- 15 FIG. 4 is a schematic flow diagram of a testing setup according to an embodiment of the present invention.
- FIG. 5 is a cross section schematic view of a wafer chamber according to an embodiment of the present invention.
- FIG. 6 is a process block diagram of a first purging process according to an embodiment of the present invention.
- 20 FIG. 7 is a process block diagram of a second purging process according to an embodiment of the present invention.
- FIG. 8 is a process block diagram of a third purging process according to an embodiment of the present invention.
- 25 FIG. 9 is a graph of hydrocarbon concentration versus time for two purge gas mixtures exiting the wafer chamber of FIG. 5, with no wafer in the chamber, according to an embodiment of the present invention.
- FIG. 10 is a graph of hydrocarbon concentration versus time for two purge gas mixtures exiting the wafer chamber of FIG. 5, with a silicon wafer in the chamber, according to an embodiment of the present invention.
- 30 FIG. 11 is an expanded version of FIG. 10, showing the time span from 10 hrs to 25 hrs in greater detail, according to an embodiment of the present invention.

FIG. 12 is a graph of *meta*- and *para*-xylene concentration versus time for three purge gas mixtures exiting the wafer chamber of FIG. 5, with a silicon wafer in the chamber, the purge gases containing 0%, 1%, and 20% oxygen, according to an embodiment of the present invention.

5 FIG. 13 is an expanded version of FIG. 12, showing the time span from 5 hrs to 25 hrs in greater detail, according to an embodiment of the present invention.

FIG. 14 is a graph of hydrocarbon concentration versus time for five purge gas mixtures exiting the wafer chamber of FIG. 5, with a silicon wafer in the chamber, the purge gases containing 0%, 0.001%, 0.01%, 0.1%, and 1.0% oxygen,
10 according to an embodiment of the present invention.

FIG. 15 is an expanded version of FIG. 14, showing the time span from 10 hrs to 24 hrs in greater detail, according to an embodiment of the present invention.

FIG. 16 is a graph of the time required to reduce ethyl benzene levels to 10 ppt using either N₂ or XCDA at various temperatures.

15 FIG. 17 is a graph of the time required to reduce *meta*- and *para*-xylene levels to 10 ppt using either N₂ or XCDA at various temperatures.

FIG. 18 is a graph of the time required to reduce *ortho*-xylene levels to 10 ppt using either N₂ or XCDA at various temperatures.

20 FIG. 19 is a graph of the time required to reduce ethyl benzene levels to 10 ppt at various oxygen concentrations.

FIG. 20 is a graph of the time required to reduce *meta*- and *para*-xylene levels to 10 ppt at various oxygen concentrations.

FIG. 21 is a graph of the time required to reduce *ortho*-xylene levels to 10 ppt at various oxygen concentrations.

25 FIG. 22 is a schematic flow diagram for the wet gas purging experiment described in Example 5.

FIG. 23 is a graph of ethylbenzene concentration versus time for four purge gas mixtures exiting the wafer chamber of FIG. 5, the purge gases containing 20% oxygen in nitrogen, 100% nitrogen, 0.5% water in nitrogen and 100 ppm water in
30 nitrogen.

FIG. 24 is a graph of combined *ortho*-xylene concentration versus time for four purge gas mixtures exiting the wafer chamber of FIG. 5, the purge gases

containing 20% oxygen in nitrogen, 100% nitrogen, 0.5% water in nitrogen and 100 ppm water in nitrogen.

FIG. 25 is a graph of *meta* and *para*-xylene versus time for four purge gas mixtures exiting the wafer chamber of FIG. 5, the purge gases containing 20%
5 oxygen in nitrogen, 100% nitrogen, 0.5% water in nitrogen and 100 ppm water in nitrogen.

FIG. 26 is a graph of the time required to ethyl benzene levels to 10 ppt using various moisture concentrations in either N₂ or XCDA.

FIG. 27 is a graph of the time required to *meta*- and *para*-xylene levels to 10
10 ppt using various moisture concentrations in either N₂ or XCDA.

FIG. 28 is a graph of the time required to *ortho*-xylene levels to 10 ppt using various moisture concentrations in either N₂ or XCDA.

FIG. 29 is a schematic flow diagram of the testing setup according to an embodiment of the invention.

15 FIG. 30 is a chromatograph of typical valve outgassing immediately after installation.

FIG. 31 is a chromatograph of typical valve outgassing at 80°C.

DETAILED DESCRIPTION OF THE INVENTION

20 Purging of contaminants is required in many applications. For example, the practice of purging UHP components and gas delivery systems in fabs has been common for many years. Purging and cleaning of equipment and substrates is also required in a number of other fields including, but not limited to, microelectronics, aerospace, optics for cleaning equipment such as LCD substrates, nanostructure
25 surfaces, wafers, reticles and optical assemblies. The disclosed methods are generally applicable for use in these fields. Historically, highly purified nitrogen and argon (less than 1 ppb oxygen, water vapor, CO, CO₂, and hydrocarbons) have been used as purge gases during the "dry down" of these components. The "dry down" process has been so named because the main purpose of the purging with
30 nitrogen or argon was to remove adsorbed surface impurities such as water and oxygen.

Purge gases are typically inert. Removal of contaminants by a purge gas may occur by different mechanisms. During the purge process, contaminants diffuse into the purge gas and are carried away in the flow of the gas stream by reaching an equilibrium between the contaminant concentration in the purge gas and on the surfaces. This requires large volumes of UHP gases sufficiently clean to absorb
5 contaminants at very low levels, typically ppb.

Contaminant species adsorbed onto surfaces (*e.g.*, silicon or stainless steel) can also be desorbed by a kinetic effect. This takes place when a purge gas at high flow rate bombards the surface and collides with the adsorbed species. Kinetic
10 energy may be transferred during the collision which can lead to desorption. In the above processes, there is nothing to prevent contaminants from re-adsorbing to the surfaces.

While not being bound by theory, it is believed that the present invention provides a new paradigm for purging contaminants from electropositive surfaces
15 (*e.g.*, certain plastics, silicon and stainless steel). It is proposed that in addition to the kinetic effect, non-inert molecules such as oxygen and water can exhibit a chemical effect. This is where oxygen and water because of their electronegative and polarized nature, respectively, have a strong affinity for the electropositive surface of the surface and form a weakly bound, adsorbed thin layer. In addition,
20 the collision of oxygen with a hydrocarbon may lead to a polarized intermediate, in which the hydrocarbon's affinity for a metal surface is weakened and the hydrocarbon can be more readily be purged. Once a collision leads to desorption, re-adsorption of the contaminant species is hindered by the oxygen thin layer. In the case of water, which forms stronger surface bonds, the thin layer is even more rigid
25 and prevents re-adsorption. Nitrogen is less capable of such protective behavior because it is less electronegative than oxygen, and the thin layer is very weakly bound and less effective. In addition, N₂ is lighter than O₂; therefore, it has less of a kinetic effect at the same velocity. This proposed mechanism is not a limitation of the instant invention.

30 In the instant invention, the effective concentration of oxygen can vary over a wide range, as explained below. The nominal concentration of 17 to 21% oxygen, corresponding to that found in ordinary air, is included in this effective

concentration range, solving both the issue of cost and the asphyxiation hazard. Furthermore, these oxygen containing purge gas mixtures can be purified to a high degree, resulting in contaminant levels in the low ppt range. The purification processes known in the current art (generally for purifying oxygen) can be applied to the purification of clean dry air (CDA), a common reagent found in most industrial fab plants, or other oxygen mixtures. Purified air for use in the present invention (i.e., containing less than about 1 ppb contaminants, particularly less than 100 ppt contaminants, such as less than about 10 ppt contaminants, for example, less than about 1 ppt contaminants) will be referred to as XCDA (extra clean dry air, XCDA is a registered trademark of Mykrolis Corporation) to clearly distinguish it from CDA, a term commonly used in the art to refer to air with up to 100 ppm contaminant, typically 10-20 ppm contaminant. Purifiers for the preparation of XCDA are manufactured, for example, by Aeronex, Inc., of San Diego, CA (e.g., the OPTICS™ Gas Purifier Series of GateKeeper® purifiers; particularly the O-series), now part of Mykrolis Corporation of Billerica, MA. Methods for preparation of oxygen and oxygen containing gases to sufficient levels of purity are well known to those skilled in the art (e.g., see US Patent 6,391,090, incorporated herein by reference). Use of a purifier and *in situ* purification are not required if a commercial source of purge gases is sufficiently pure for the intended application. The concentration of contaminants in a purge gas can be measured by a suitably sensitive technique, such as the PAC™ Parts-Per-Trillion Analyzer Cart marketed by Aeronex. Typically, such techniques involve collecting contaminants from a gas stream over or within a cold trap for an amount of time sufficient to allow a trace contaminant to accumulate to levels that can be accurately quantified with available instrumentation after re-volatilization of the gas.

The oxygen-containing purified gas mixture is comprised of oxygen in a concentration between 99 volume % and 0.0001 volume %, preferably between 25 volume % and 0.1 volume % (e.g., between 25 volume % and 1 volume %), and more preferably between 21 volume % and 1.0 volume %. Additionally, the purge gas optionally contains water vapor at 100 ppm to 2 volume %, preferably 100 ppm to 0.5 volume %. The remainder of the mixture should be an inert gas chosen from among the group of nitrogen, argon, the noble gases, carbon dioxide, and methane.

Preferably, nitrogen should be the major inert component, with all other components of the inert gas being present at below about 1 volume %. Preferably, the levels of non-methane hydrocarbons, volatile bases, volatile acids, refractory compounds, and volatile metal compounds should be below 1 ppb. Preferably, the levels of
5 contaminants should be below 100 ppt, more preferably below 10 ppt, most preferably below 1 ppt. The specific purification means is well known to those skilled in the art.

The effective concentration of water in the purge gases of the instant invention, when present, may vary from about 100 ppm to about 2 volume % in the
10 apparatus to be purged, typically no more than 0.5 volume %. Other components of the purge gas (*e.g.*, oxygen, inert gases) are as described immediately above for oxygen-containing purge gases. Theoretically, higher water concentrations can be used; however, it can be impractical to remove such high concentrations from an apparatus before use. Because oxygen and water have been historically considered
15 impurities, their use for removal of contaminants is unexpected. It shall be shown that not only are oxygen and/or water mixtures as effective as UHP nitrogen for removing hydrocarbons from surfaces, they actually show improved performance.

The purging methods disclosed herein can be carried out over a wide range of temperatures. Typically, the methods are carried out at temperatures between
20 ambient temperature (about 20°C) and 50°C. Nevertheless, the methods optionally can be carried out at temperatures of up to about 100°C or even 150°C. The temperature is typically selected based upon criteria including thermal tolerance of the components to be cleaned, the volatility of the contaminants at various temperatures and the temperatures that the components (*e.g.*, silicon wafers) will be
25 subjected to during subsequent steps of the manufacturing process.

FIG. 4 is a schematic flow diagram of a testing setup according to an embodiment of the present invention. A double dilution system 100 as described previously is utilized to create known hydrocarbon concentrations from gas standard 114. Concentration curves for other contaminants can be similarly established using
30 methods well known to those skilled in the art. Nitrogen, XCDA, or other oxygen containing mixtures are fed to the carrier input 102. When producing a hydrocarbon mixture to contaminate the surfaces of a test device, nitrogen is chosen at input 102,

the hydrocarbon component concentrations being determined by mass flow controllers 108-110 and the concentration of hydrocarbons in gas standard 114. When the purging performance of the purge gas is being evaluated, either nitrogen or a mixture of nitrogen and oxygen are chosen at input 102, with valve 109 closed and valves 107 and/or 111 open. Purifier 104 purifies the nitrogen or nitrogen-oxygen mixtures. The gas mixtures created by system 100 are directed to the device under test (DUT) 402. The hydrocarbon concentrations leaving the DUT 402 are introduced into the input 122 of the gas chromatograph gas analysis system 400, where the hydrocarbon levels can be measured, as previously described and known to those skilled in the art.

Generally, the purging effectiveness of the oxygen mixtures was determined by first purging a test device with a hydrocarbon mixture in nitrogen to saturate the surfaces with hydrocarbons, then removing the hydrocarbons in the gas, and continuing the purging process with either UHP nitrogen or purified oxygen mixtures, and measuring the hydrocarbon concentrations in the gas leaving the DUT. The faster the hydrocarbon concentration drops in the gas exiting the DUT, the more effective the purging process.

FIG. 5 is a cross section schematic view of a wafer chamber 500 according to an embodiment of the present invention. The wafer chamber is used to evaluate the effectiveness of purging hydrocarbons from stainless steel and silicon surfaces. The chamber has an inlet port 506, an outlet port 508, and supports 512 to hold 100 mm diameter silicon substrate 510 in the purge gas environment. The internal surfaces of the wafer chamber are electropolished 316 stainless steel. The wafer chamber diameter D (ref 502) was 6.0 inches, having a height dimension H (ref 504) of 3.9 inches. Wafer chamber 500 was connected as the DUT 402 in the system shown in FIG. 4.

FIG. 6 is a process block diagram 1900 of a first purging process according to an embodiment of the present invention. The process begins with step 1902, wherein a purge gas mixture containing oxygen is purified. Moisture, when added, is typically added to the oxygen containing gas mixture after purification with step 1928 by passage through a humidifying device 1930. Alternatively, the purge gas contains moisture, but no oxygen. Moisture may be added by any method known to

those skilled in the art (*e.g.*, a bubbler). However, methods that allow careful control of the amount of moisture added are preferred. A number of types of calibrated tubing with defined water permeabilities are known to those skilled in the art and are commercially available. Tubes are made of nylon, silicon, Teflon®
5 (poly(ethylene tetrafluoride); PTFE) and Nafion® (Dupont). The purified purge gas is passed through a chamber through which the tubing containing ultrapure water (less than 1 ppb contaminants) runs. The amount of moisture entering the purified purge gas can be determined for a specific flow rate of both water and purge gas. Such methods are well known to those skilled in the art. The humidified purge gas
10 is delivered to the device in step 1932.

In step 1904, the purified purge gas containing oxygen and/or water is fed to the device to be purged. Optionally, the device may be heated in step 1908 to reduce the purge time. If heating is employed, the process proceeds along paths 1906 and 1910 to step 1912. In step 1912, a portion of the internal surfaces are contacted with
15 the oxygen and/or water containing purge gas. In step 1914, a portion of the contaminants present on the internal surfaces of the device are transferred to the purge gas, creating a contaminated purge gas. Surfaces contained within the device being purged may be metal, metal oxides, intermetallics, silicon, silicon oxides, ceramics, nitrides and/or plastics. Preferably, the surfaces are electropolished
20 stainless steel, silicon, and oxides of silicon. Also in step 1914, the contaminated purge gas is removed from the device. In step 1916, the purging process is continued until the contaminant concentration in the purge gas is below a predetermined limit. This limit may be less than 1 ppb, preferably less than 100 ppt, more preferably less than 10 ppt, most preferably less than 1 ppt. In a preferred
25 optional step 1918, an oxygen and water containing purge gas or water containing purge gas is removed by purging with a dry gas including oxygen, nitrogen or other inert gas to remove the water, which is incompatible with a number of high purity applications. In another preferred optional step 1918, an oxygen containing purge gas is removed by purging with nitrogen or another inert gas, if the device is to be
30 placed into service where oxygen is considered undesirable. These optional steps 1918 are preferably conducted while the device is heated. If the device was heated,

the device should be cooled in step 1922 and returned to service in step 1926 via paths 1920 and 1924.

FIG. 7 is a process block diagram 2000 of a second purging process according to an embodiment of the present invention. The process begins with step 5 2002, wherein a purge gas mixture containing oxygen is purified. The requirements for the inert gas are as described above. Purification means to obtain such high purity gases are well known to those skilled in the art. In step 2004, the purified purge gas containing oxygen is optionally fed, in step 2030, to a humidifying device 2032 and returned in step 2034 to be fed to the device to be purged. Alternatively, 10 the purified purge gas is humified, but contains no oxygen. Optionally, the device may be heated in step 2008 to reduce the purge time. If heating is employed, the process proceeds along paths 2006 and 2010 to step 2012. In step 2012, a portion of the internal surfaces are contacted with the oxygen and/or water containing purge gas. In step 2016, a portion of the contaminants present on the internal surfaces of 15 the device are transferred to the purge gas, creating a contaminated purge gas. Surfaces contained within the device being purged can be metal, metal oxides, intermetallics, silicon, silicon oxides, ceramics, nitrides and/or plastics. Preferably, the surfaces are electropolished stainless steel, silicon, and oxides of silicon. Also in step 2016, the contaminated purge gas is removed from the device. In step 2018, the 20 purging process is continued for a predetermined time period. This may be more convenient than basing the purge time on the measurement of contaminant concentration, which requires complex and sensitive analytical equipment. In a preferred optional step 2020, an oxygen and water containing purge gas or water containing purge gas is removed by purging with a dry gas including oxygen, 25 nitrogen or other inert gas to remove the water. If the device is to be placed into service where oxygen is considered undesirable, nitrogen or inert gas should be used for the post-cleaning purge. If the device was heated, the device should be cooled in step 2024 and returned to service in step 2028 via paths 2022 and 2026.

FIG. 8 is a process block diagram 2100 of a third purging process according 30 to an embodiment of the present invention. In step 2102, an inert gas is supplied. The requirements for the inert gas are as described above. In step 2104, the inert gas is purified via a process or processes well known to those skilled in the art. In step

2106, essentially pure oxygen or a mixture containing oxygen is supplied. In step 2108, the oxygen or oxygen mixture is purified via a process or processes that are well known to those skilled in the art. In step 2110, the purified oxygen or oxygen mixture from step 2108 is combined with the purified inert gas from step 2104.

5 Optionally, the purification stages may be performed after the combining of the gases in step 2110. After step 2110, the purified purge gas containing oxygen is optionally fed, in step 2136, to a humidifying device 2138 and returned in step 2140, so that the purified purge gas containing oxygen and/or water is fed to the device to be purged. Optionally, the device is heated in step 2116 to reduce the purge time. If

10 heating is employed, the process proceeds along paths 2114 and 2118 to step 2120. In step 2120, a portion of the internal surfaces are contacted with the oxygen containing purge gas. In step 2122, a portion of the contaminants (*e.g.*, hydrocarbons) present on the internal surfaces of the device are transferred to the purge gas, creating a contaminated purge gas. Surfaces contained within the device

15 being purged may be metal, metal oxides, intermetallics, silicon, silicon oxides, ceramics, nitrides and/or plastics. Preferably, the surfaces are electropolished stainless steel, silicon, and oxides of silicon. Also in step 2122, the hydrocarbon purge gas is removed from the device. In step 2124, the purging process is continued for a predetermined time period, or to a predetermined hydrocarbon level.

20 This level is typically less than 100 ppt, but is preferably less than 10 ppt. In a preferred optional step 2126, the oxygen and water containing purge gas is removed by purging with a dry gas including oxygen, nitrogen or other inert gas to remove the water. If the device is to be placed into service where oxygen is considered undesirable, nitrogen or inert gas should be used for the post-cleaning purge. If the

25 device was heated, the device should be cooled in step 2130 and returned to service in step 2134 via paths 2128 and 2132.

EXAMPLE 1

30 The effectiveness of removing hydrocarbons from 316 stainless steel electropolished surfaces with oxygen mixtures is demonstrated in this example. 316 stainless steel electropolished surfaces are widely used in UHP gas distribution systems in mass flow controllers, pressure regulators, and interconnecting pipe and

tubing. They are also widely used as a process chamber material in semiconductor manufacturing equipment. An empty (no silicon wafer 510 present) wafer chamber 500, was first purged with a nitrogen-hydrocarbon mixture containing approximately 10 ppb each of benzene, toluene, ethyl-benzene, *meta*- and *para*-xylene, and *ortho*-
5 xylene for approximately 3.5 hours. Following the hydrocarbon exposure, the wafer chamber was purged with UHP nitrogen and the hydrocarbon concentrations in the purge gas exiting the chamber were measured. The hydrocarbon exposure was then repeated. Following the second hydrocarbon exposure, the wafer chamber was purged with purified XCDA, which contained approximately 20% oxygen by
10 volume.

FIG. 9 is a graph 600 of hydrocarbon concentration 604 versus time 602 for two purge gas mixtures exiting the wafer chamber of FIG. 5, with no wafer in the chamber, according to an embodiment of the present invention. Broken curve 606 shows the total concentration decay response of all six hydrocarbons in the purge
15 gas leaving the wafer chamber with a pure nitrogen purge gas. Solid curve 608 shows the total concentration decay response of all six hydrocarbons in the purge gas leaving the wafer chamber with a purified XCDA purge gas. Ref 610 indicates the point where the hydrocarbon containing purge gas was substituted with the nitrogen or XCDA.

20 The elution times of the hydrocarbons in curves 606 and 608 were compared to the time it would take to dilute the original 60 ppb hydrocarbon concentration to 10 ppt, given the wafer chamber volume of approximately 1.5 liters and purge flow rate of 0.75 liters/min. For a uniformly mixed system, it would take about 8.7 time constants to reduce an initial 60 ppb concentration to 10 ppt. The time constant is
25 defined as the wafer chamber volume divided by the purge flow rate. At a time constant of approximately two minutes, simple dilution would take under 20 minutes to reach 10 ppt from an initial starting point of 60 ppb. The actual time for either the XCDA or pure nitrogen to reach 10 ppt is considerably longer, indicating that removal from the internal stainless steel surfaces is dominating the hydrocarbon
30 elution from the wafer chamber. Other tests have shown that once the hydrocarbons are reduced to very low levels (10 ppt and below) by purified XCDA, subsequent

purging by UHP nitrogen does not produce hydrocarbon concentrations above the levels last obtained with the XCDA.

EXAMPLE 2

5 In this example, the test described in Example 1 was repeated, with the exception that a bare 100 mm (4 inch) silicon substrate 510 was placed in the wafer chamber 500 prior to exposure to the nitrogen-hydrocarbon mixture. FIG. 10 is a graph 700 of total hydrocarbon concentration 704 versus time 702 for two purge gas mixtures exiting the wafer chamber of FIG. 5, with a silicon wafer in the chamber, according to an embodiment of the present invention. Curve 706 shows the decay in hydrocarbon concentration while the wafer chamber and wafer are purged with UHP nitrogen. Curve 708 shows the decay in hydrocarbon concentration while the wafer chamber and wafer are purged with purified XCDA. Ref 710 indicates the approximate point where feed of nitrogen-hydrocarbon mixture was terminated.

10 Curves 706 and 708 clearly indicate hydrocarbon removal from silicon substrates is significantly slower than the stainless steel surfaces of the wafer chamber. As in the previous Example 1, the oxygen containing purge gas (curve 708) shows a more rapid reduction in hydrocarbon concentration, when compared to UHP nitrogen (curve 706). FIG. 11 is an expanded version of FIG. 10, showing the time span from

15 10 hrs to 25 hrs in greater detail. Here it can be more clearly seen from graph 800 that hydrocarbon concentration 804 versus time 802 for the XCDA purge (curve 808) is in advance of the UHP nitrogen curve 806. At the 20 ppt concentration level, the UHP nitrogen response lags the XCDA response by nearly 5 hours. This, of course, means that it would require 5 hours longer to purge the wafer chamber and

20 wafer to the 20 ppt level with UHP nitrogen.

25

EXAMPLE 3

FIG. 12 is a graph 900 of *meta*- and *para*-xylene concentration 904 versus time 902 for three purge gas mixtures exiting the wafer chamber of FIG. 5, with a silicon wafer in the chamber, the purge gases containing 0%, 1%, and 20% oxygen, according to an embodiment of the present invention. In this example, 1% oxygen and 20% oxygen (in nitrogen) are compared to UHP nitrogen. The hydrocarbon

30

mixture used was approximately 10 ppb of *meta*-xylene and 10 ppb of *para*-xylene in nitrogen. As in Example 2, a silicon substrate was placed in the wafer chamber prior to the hydrocarbon exposure. Curve 906 in FIG. 12 shows the concentration response of both xylenes as a function of time during a UHP nitrogen purge. Curve 908 shows the concentration response of both xylenes as a function of time during a 1% oxygen (by volume) in nitrogen purge. Curve 910 shows the concentration response of both xylenes as a function of time during a 20% oxygen (by volume) in nitrogen (XCDA) purge. Ref 912 indicates the point at which the hydrocarbon feed gas was terminated. FIG. 13 is an expanded version of FIG. 12, showing the time span from 5 hrs to 25 hrs in greater detail. Here it can be more clearly seen from graph 1000 that hydrocarbon concentration 1004 versus time 1002 for the 1% oxygen purge gas (curve 1008) and the 20% oxygen purge gas (curve 1010) is in advance of the UHP nitrogen curve 1006. From a comparison of the three curves 1006-1010, it can be noted that 1% oxygen is as effective as 20% for hydrocarbon levels above 10 ppt, but that the higher oxygen concentration has a slight advantage at levels below 10 ppt. Both oxygen containing purge gases demonstrate a significant advantage over purging with UHP nitrogen.

EXAMPLE 4

FIG. 14 is a graph 1100 of hydrocarbon concentration 1104 versus time 1102 for five purge gas mixtures exiting the wafer chamber of FIG. 5, with a silicon wafer in the chamber, the purge gases containing 0%, 0.0001%, 0.01%, 0.1%, and 1.0% oxygen, according to an embodiment of the present invention. The hydrocarbon-nitrogen contamination mixture was 60 ppb total hydrocarbon concentration, as described in Example 1. Data representing the purge response of UHP nitrogen (ref 1106, curve 1116), 0.0001% oxygen (by volume) in nitrogen 1108, 0.01% oxygen (by volume) in nitrogen 1110, 0.1% oxygen (by volume) in nitrogen 1112, and 1% oxygen (by volume) in nitrogen (ref 1114, curve 1118) are plotted in graph 1100. All the data fall between the 0% oxygen curve 1116 (UHP nitrogen) and the 1% oxygen curve 1118, as might be expected. Purging effectiveness increases as oxygen concentration increases within the ranges of oxygen concentration shown. FIG. 15 is an expanded version of FIG. 14, showing the time span from 10 hrs to 24

hrs in greater detail. The graph 1200 of hydrocarbon concentration 1204 versus time 1202 is plotted with data representing the purge response of UHP nitrogen (ref 1206, curve 1216), 0.0001% oxygen 1208, 0.01% oxygen 1210, 0.1% oxygen 1212, and 1% (ref 1214, curve 1218). See FIGS. 16-21 which show dry-down times versus
5 temperature or concentration.

EXAMPLE 5

The effectiveness of removing hydrocarbons from 316 stainless steel electropolished surfaces with water mixtures is demonstrated in this example using a
10 method similar to that in Example 1. See FIG. 22. Initially purified nitrogen gas was mixed with a six-component hydrocarbon gas standard (benzene, toluene, ethylbenzene, xylenes; BTEX) to create a known challenge of 60 ppb total organic compounds (TOC). The wafer chamber, housing a wafer, was purged with the challenge gas under standard operating conditions of 0.75 slm, 30 psig and ambient
15 temperature. The wafer chamber effluent was measured for hydrocarbon level using a gas chromatograph with a flame ionization detector until its concentration reached 60 ppb \pm 2 ppb hydrocarbon. The stabilization time for the chamber to condition occurred after 4-5 hours.

After the wafer chamber was saturated with the 60 ppb TOC, the BTEX
20 challenge was turned off and moisture or oxygen was added to the nitrogen gas stream as indicated. The wafer chamber effluent was monitored until its TOC concentration dried down below the 10 ppt level for each contaminant.

FIG. 23 is a graph 1600 of time 1602 versus ethylbenzene concentration 1604 for four purge gas mixtures exiting the wafer chamber of FIG. 5, the purge
25 gases containing 100% nitrogen, 20% oxygen, 0.5% water and 100 ppm water according to an embodiment of the present invention. The hydrocarbon-nitrogen contamination mixture was 60 ppb total hydrocarbon concentration, as described in Example 1. Data representing the purge response of ethylbenzene to UHP nitrogen 1606, 20% oxygen (by volume) in nitrogen 1608, 100 ppm water (by volume) in
30 nitrogen 1610 and 0.5% water (by volume) in nitrogen 1612 are plotted in graph 1600. Purging effectiveness increases as water concentration increases within the ranges of water concentration shown.

FIG. 24 is a graph 1700 of time 1702 versus *ortho*-xylene concentration 1704 for four purge gas mixtures exiting the wafer chamber of FIG. 5, the purge gases containing 100% nitrogen, 20% oxygen, 0.5% water and 100 ppm water according to an embodiment of the present invention. The hydrocarbon-nitrogen 5 contamination mixture was 60 ppb total hydrocarbon concentration, as described in Example 1. Data representing the purge response of *ortho*-xylene to UHP nitrogen 1706, 20% oxygen (by volume) in nitrogen 1708, 100 ppm water (by volume) in nitrogen 1710 and 0.5% water (by volume) in nitrogen 1712 are plotted in graph 1700. Purging effectiveness increases as water concentration increases within the 10 ranges of water concentration shown.

FIG. 25 is a graph 1800 of time 1802 versus *para*- and *meta*-xylene 1804 for four purge gas mixtures exiting the wafer chamber of FIG. 5, the purge gases containing 100% nitrogen, 20% oxygen, 0.5% water and 100 ppm water according to an embodiment of the present invention. The hydrocarbon-nitrogen 15 contamination mixture was 60 ppb total hydrocarbon concentration, as described in Example 1. Data representing the purge response of *para*- and *meta*-xylene to UHP nitrogen 1806, 20% oxygen (by volume) in nitrogen 1808, 100 ppm water (by volume) in nitrogen 1810 and 0.5% water (by volume) in nitrogen 1812 are plotted in graph 1600. Purging effectiveness increases as water concentration increases 20 within the ranges of water concentration shown.

Table 1
Reduction in Dry Down Time Using Moisture

Purge Gas Compared	Dry-Down Times Diffence(Hr)		
	Ethylbenzene	m,p-Xylene	o-Xylene
Dry N2 and 0.1%H2O in N2	5.03	9.60	7.57
Dry N2 and 0.5%H2O in N2	6.37	12.25	9.57
Dry XCDA and 0.1%H2O in XCDA	2.23	5.42	4.83
Dry XCDA and 0.5%H2O in XCDA	3.70	6.93	4.93

25

See FIGs. 26-28 which show dry-down times versus temperature or concentration.

EXAMPLE 6

In a comparative test to determine the efficacy of XCDA as compared to nitrogen for decontamination of UHP equipment, a quantitative measurement system was assembled incorporating three commercial UHP diaphragm valves, each from a different manufacturer. The setup is shown in FIG. 29, 1300. To perform outgassing tests, each valve under test 1302, VUT, was connected directly upstream of the cold trap 1304 as shown. Purified sample gas (N₂ or XCDA) was sent through each VUT with a gas purity specification of less than 1 ppt hydrocarbon. The supply N₂ and XCDA were purified with an inert purifier (Aeronex, SS-500KF-I-4R) and optics purifier (Aeronex, SS-700KF-O-4R), respectively. A heater tape and temperature probe were wrapped around the VUT to heat and monitor the temperature (not shown). As the gas purged through the VUT, any desorbed contaminants were collected downstream in the cold trap for hydrocarbon analysis in the gas chromatogram 1304.

Valves were selected as representative of UHP system contamination sources since prior investigations had shown evidence of hydrocarbon contamination being generated by outgassing from elastomeric components in the valves. Detection and measurement was by means of cold trap collection and gas chromatographic measurement. The size of the contaminants was determined by retention time on the column (TOC) as compared to known standards. Chromatographs 1400 and 1500 showing time in minutes 1402 and 1502 versus mVolts 1404 and 1504, respectively from the outgassing of valves at two different temperatures, ambient and about 80°C, are shown in FIGs. 30 and 31. A rough analysis of the size of the contaminants based on the chromatographs is presented in Table 2 below.

Table 2
Analysis of contaminants by Total Organic Contaminants (TOC) by GC/FID

Time	Compound	% outgassing
<10 min	< 5 carbons	10-20%
10-16 min	6-10 carbons	0-5%
16-25 min	11-15 carbons	20-40%
>25 min	> 15 carbons	50-80%

It should be noted that the majority of the contaminants released are high molecular weight contaminants. This is in contrast to the prior examples where purging of low molecular weight hydrocarbons (*i.e.*, less than 8 carbons) was analyzed.

5 Measurements were made at 0 and 60 minutes of system operation at ambient temperature (approximately 20°C) and at 0, 60 and 720 minutes at 80°C. Measurements were made of both one-pass and two-pass purges by the different gases. In each case a nitrogen purge was followed by an XCDA purge. In the two-pass test the XCDA purge was followed by a second nitrogen purge. Tests of the
10 three different UHP valves produced three different results. One valve started out with a low level of hydrocarbon outgassing and did not exceed 100 ppt even during elevated thermal XCDA testing, while another produced temperature sensitive contamination results. The remaining valve started out at 100 and peaked at 1000 ppt. On the positive side all valves through proper purging and thermal cycling were
15 able to achieve levels at or below the 1 ppt lower limit of the detection capability of our test instruments. This indicates that through proper preconditioning any of these valves could be used in UHP piping system to deliver 1 ppt gas to the process. Results for the valve producing the 100-1000 ppt outgassing were as shown below in Table 3.

Table 3
Nitrogen vs. XCDA Purging of UHP Valves

No. of Passes	Time	Temperature	Nitrogen		XCDA
	(minutes)	(°C)	(ppt)		(ppt)
1	0	Ambient	100		50
1	60	Ambient	180		50
1	0	80	1000		40
1	60	80	700		100
1	720	80	12		0
			1st	2nd	
2 (N2)	0	Ambient	100	0	50
2 (N2)	60	Ambient	180	0	50
2 (N2)	0	80	1000	0	40
2 (N2)	60	80	700	0	100
2 (N2)	720	80	12	0	0

- 5 It will be evident from the data of Table 3 that over all of the temperature and time ranges, purges with nitrogen produced only limited and quite unacceptable reductions of the hydrocarbon contamination of the valve. The subsequent purge with the XCDA reduced the hydrocarbon contaminant level to much lower levels, bettering the nitrogen purge lower limit by factors of 2-25. Further the XCDA
- 10 purges to the low levels occurred in very short times as compared to the time required for the nitrogen purges to effect significant reductions. (The increases seen for the first nitrogen purge at ambient temperature and the XCDA purge at 80°C between 0 and 60 minutes are believed to be due to the time required for some hydrocarbon contaminants within the elastomeric components to migrate to the
- 15 surface for purging. This is a physical phenomenon of the elastomeric materials of the valve and not representative of the purge capabilities of the respective gases.)

The generally accepted protocol for UHP gas line validation requires extensive purging with nitrogen followed by verification that the line is contaminant free in a nitrogen purge environment. However, with all the valves XCDA

volatilized additional hydrocarbons which remain after UHP nitrogen cleaning and thermal cycling. Even at ambient temperature, additional hydrocarbons were released when exposed to an oxygen rich purge gas.

A second series of tests were conducted to determine any effect from the order in which the purge gases were used. Two equivalent commercial valves from the same manufacturer were tested for hydrocarbon decontamination. One (A1) was purged with nitrogen followed by XCDA, and the other (A2) with XCDA followed by nitrogen. The results are presented in Table 4 below:

Table 4
Nitrogen/XCDA Purge vs. XCDA/Nitrogen Purge

Time (minutes)	Temperature (°C)	Valve A1		Valve A2	
		N2 (ppt)	XCDA (ppt)	XCDA (ppt)	N2 (ppt)
0	ambient	50	50	50	90
60	ambient	10	190	19	9
0	80	220	220	510	2
60	80	200	100	35	2
720	80	10	5	0	0

The XCDA step at ambient temperature produced results similar to the nitrogen purge. However, when Valve A2 was heated to 80°C under XCDA purge, the hydrocarbon outgassing rate increased significantly and then dropped quickly to below the limits of the detection equipment. Repeating the test in nitrogen showed little improvement. When purging with nitrogen, UHP components produced a continuous release of hydrocarbons. Actual peak values often did not occur until long after the initiation of purging due to the slow migration of heavier hydrocarbons through the piping system.

While this invention has been particularly shown and described with references to preferred embodiments thereof, it will be understood by those skilled in the art that various changes in form and details may be made therein without departing from the scope of the invention encompassed by the appended claims.

CLAIMS

What is claimed is:

1. A method for the removal of airborne molecular contaminants (AMC) from a
5 surface, comprising:
 - contacting at least a portion of the area surrounding a surface with a
purified purge gas, wherein the purge gas comprises oxygen, water or a
combination thereof, and the purified purge gas has an AMC concentration
less than about 1 part per billion (ppb) on a volume basis;
 - 10 producing a contaminated purge gas by transferring a portion of the
contaminants from the surface into the purified purge gas; and
 - removing the contaminated purge gas from the area surrounding the
surface.
- 15 2. A method for the removal of airborne molecular contaminants (AMC) from a
surface, comprising:
 - purifying a purge gas to produce a purified purge gas, wherein the
purge gas comprises oxygen and the purified purge gas has an AMC
concentration less than about 1 part per billion (ppb) on a volume basis;
 - 20 contacting at least a portion of the area surrounding a surface with the
purified purge gas;
 - producing a contaminated purge gas by transferring a portion of the
contaminants from the surface into the purified purge gas; and
 - removing the contaminated purge gas from the area surrounding the
25 surface.
3. The method as in claim 2, wherein the method is repeated until the
contaminant concentration in the contaminated purge gas is below about 1
ppb AMC on a volume basis.
- 30 4. The method as in claim 2, wherein the purified purge gas has a concentration
of less than about 100 parts per trillion (ppt) AMC on a volume basis.

5. The method as in claim 2, wherein the purified purge gas has a contaminant concentration of less than about 10 ppt AMC on a volume basis.
- 5 6. The method as in claim 2, wherein the purified purge gas has a contaminant concentration of less than about 1 ppt AMC on a volume basis.
7. The method as in claim 2, wherein the purified purge gas further comprises water.
- 10 8. The method as in claim 7, wherein the water comprises about 100 parts per million (ppm) to about 2% by volume of the purge gas.
9. The method as in claim 8, wherein the water comprises about 100 ppm to
15 about 0.5% by volume of the purge gas.
10. The method as in claim 2, wherein the surface comprises an interior surface of a device wherein the device encloses a space.
- 20 11. The method of claim 10, wherein the device encloses at least one silicon substrate.
12. The method of claim 2, wherein the surface is the interior surface of an ultrahigh purity gas line component.
- 25 13. The method of claim 2, wherein the surface is the interior surface of a valve.
14. The method as in claim 2, further comprising purging the device with an inert gas after removing said contaminated gas from said device.
- 30 15. The method as in claim 14, wherein said inert gas is selected from the group consisting of nitrogen, argon, noble gases, methane and combinations thereof.

16. A method for the removal of airborne molecular contaminants (AMC) from a surface, comprising:
- 5 purifying a purge gas to produce a purified purge gas, wherein the purge gas comprises oxygen at a concentration between about 1% and 25% on a volume basis and the purified purge gas has an AMC concentration less than about 1 part per billion (ppb) on a volume basis;
- contacting at least a portion of the area surrounding a surface with the purified purge gas;
- 10 producing a contaminated purge gas by transferring a portion of the contaminants from the surface into the purified purge gas; and
- removing the contaminated purge gas from the area surrounding the surface.
- 15 17. A method as in claim 16, comprising continuing the method until the contaminant concentration in the contaminated purge gas is below 1 ppb on a volume basis.
18. The method as in claim 16, wherein the purified purge gas has a contaminant concentration of less than 10 parts per trillion (ppt) AMC on a volume basis.
- 20 19. The method as in claim 16, wherein the purified purge gas has a contaminant concentration of less than 1 ppt AMC on a volume basis.
- 25 20. The method as in claim 16, wherein the purified purge gas further comprises water.
21. The method as in claim 20, wherein the water comprises about 100 parts per million (ppm) to about 2% by volume of the purge gas.
- 30 22. The method as in claim 16, wherein the surface comprises an interior surface of a device wherein the device encloses a space.

23. The method as in claim 22, wherein the device encloses at least one silicon substrate.
24. A method for the removal of airborne molecular contaminants (AMC) from a surface, comprising:
5 purifying a purge gas to produce a purified purge gas, wherein the purge gas comprises water and the purified purge gas has an AMC concentration less than about 1 part per billion (ppb) on a volume basis;
 contacting at least a portion of the area surrounding a surface with the
10 purified purge gas;
 producing a contaminated purge gas by transferring a portion of the contaminants from the surface into the purified purge gas; and
 removing the contaminated purge gas from the area surrounding the surface.
- 15 25. The method as in claim 24, wherein the steps are repeated until said contaminant concentration in the contaminated purge gas is below about 1 ppb on a volume basis.
- 20 26. The method as in claim 24, wherein the purified purge gas has a contaminant concentration of less than about 10 parts per trillion (ppt) AMC on a volume basis.
27. The method as in claim 24, wherein the purified purge gas has a contaminant
25 concentration of less than about 1 ppt AMC on a volume basis.
28. The method as in claim 24, wherein the water comprises 100 parts per million (ppm) to 2% by volume of the purge gas.
- 30 29. The method as in claim 28, wherein the water comprises 100 ppm to 0.5% by volume of the purge gas.

30. The method as in claim 24, further comprising purging the device with an inert gas after removing said contaminated gas from said device.
31. The method as in claim 30, wherein said inert gas is selected from the group
5 consisting of nitrogen, argon, noble gases, methane and combinations thereof.
32. The method as in claim 24, wherein the surface comprises an interior surface
10 of a device wherein the device encloses a space.
33. A method as described in claim 32, wherein the device encloses at least one silicon substrate.
34. The method of claim 24, wherein the surface is the interior surface of an
15 ultrahigh purity gas line component.
35. The method of claim 24, wherein the surface is the interior surface of a valve.

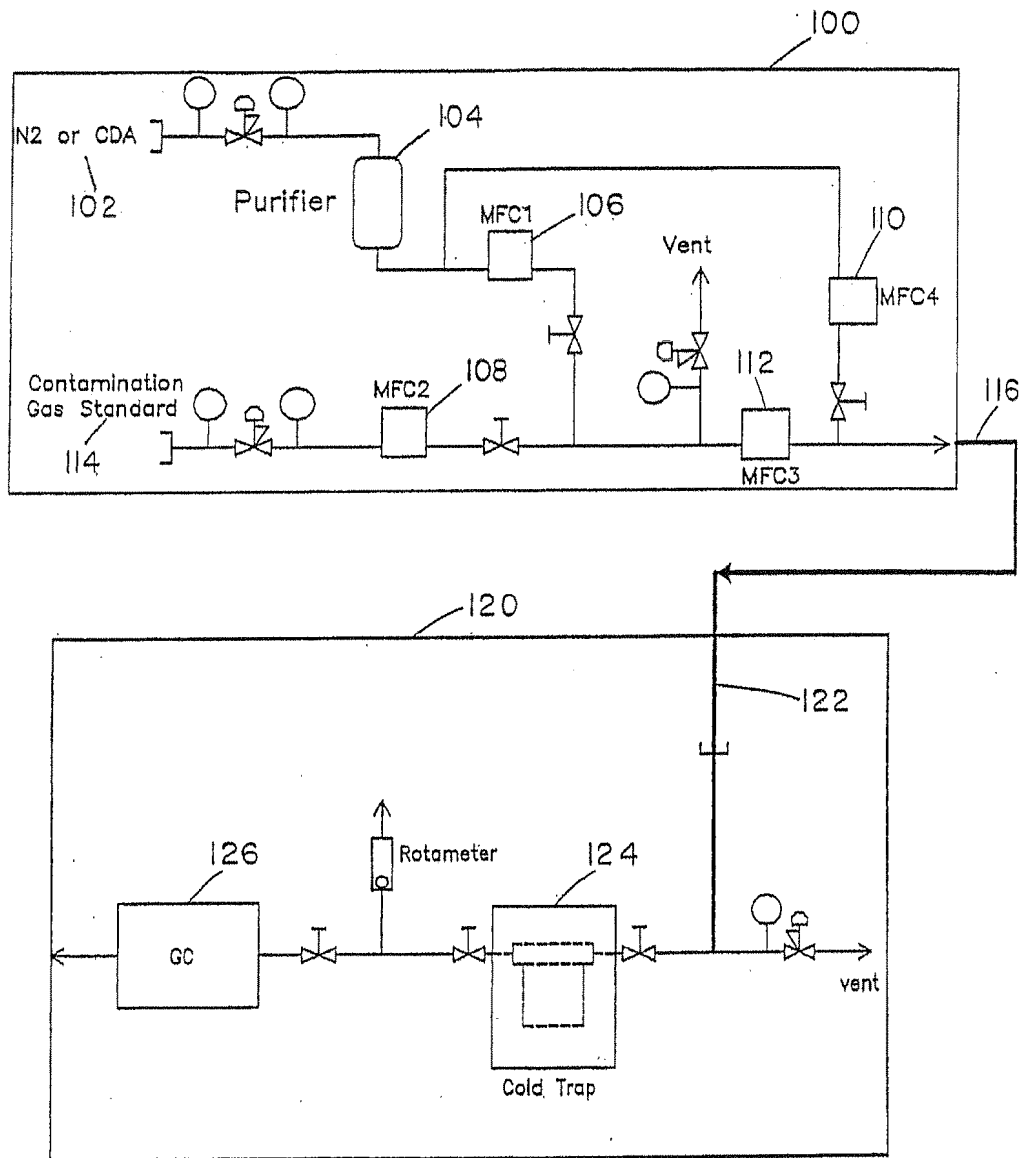

FIG. 1 PRIOR ART

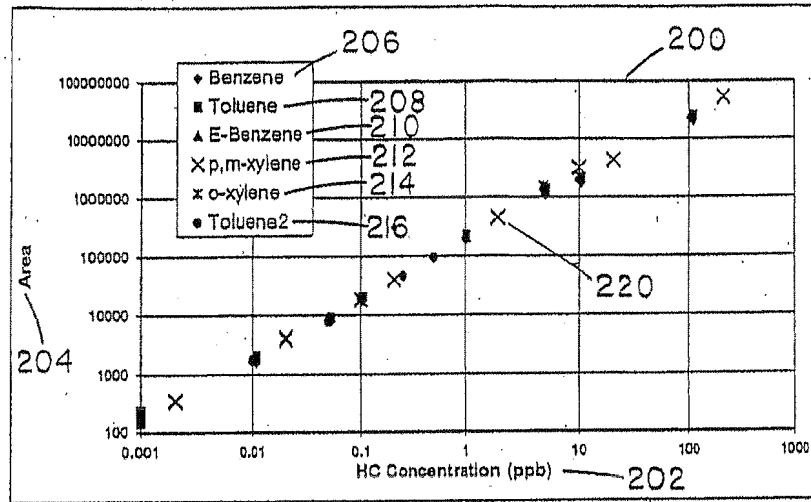

FIG. 2 PRIOR ART

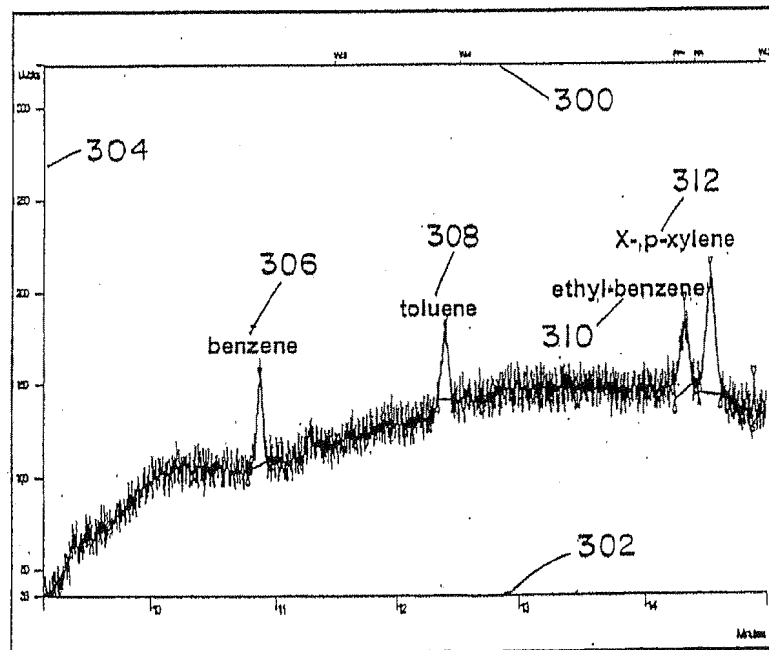

FIG. 3 PRIOR ART

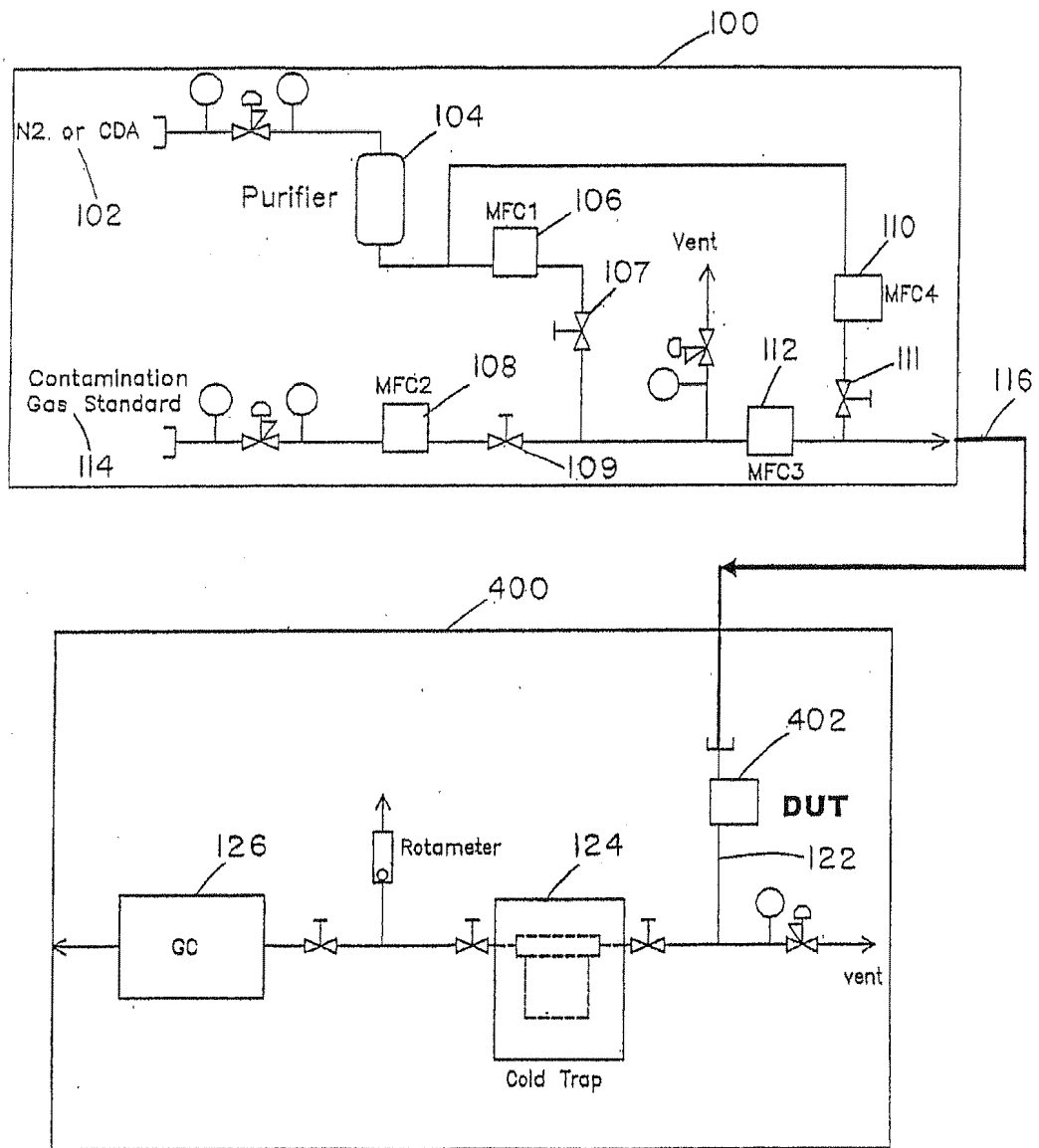
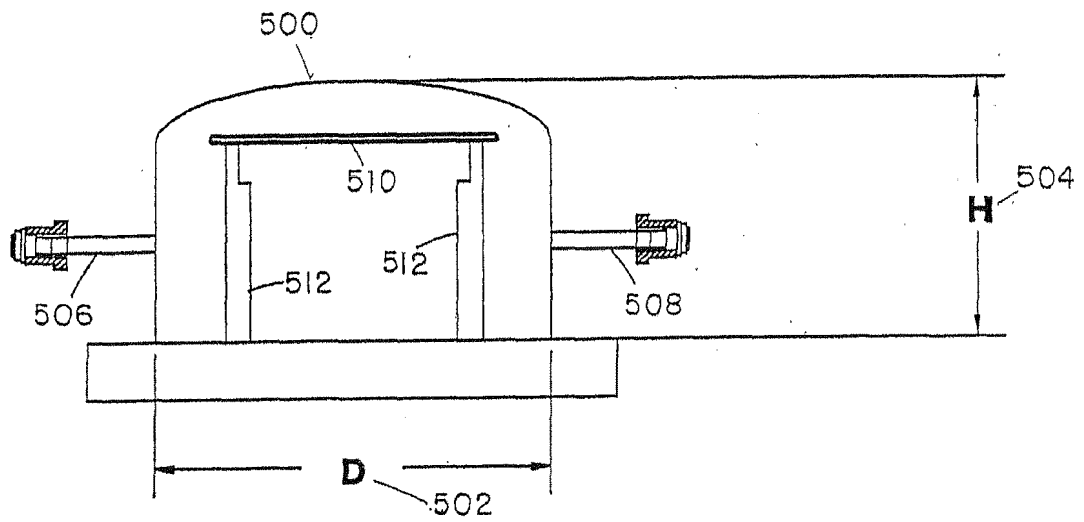

FIG. 4



Wafer Chamber

FIG. 5

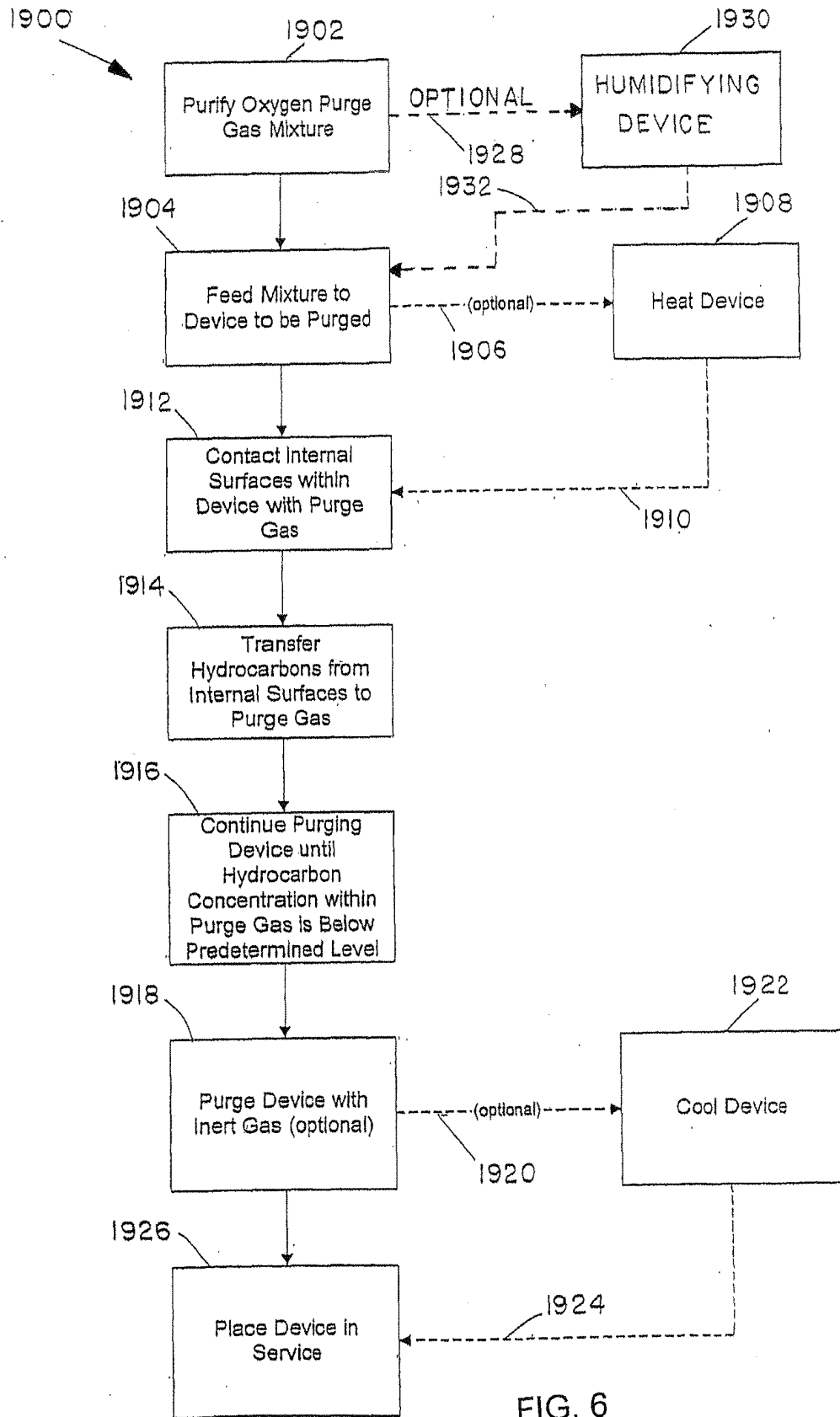

FIG. 6

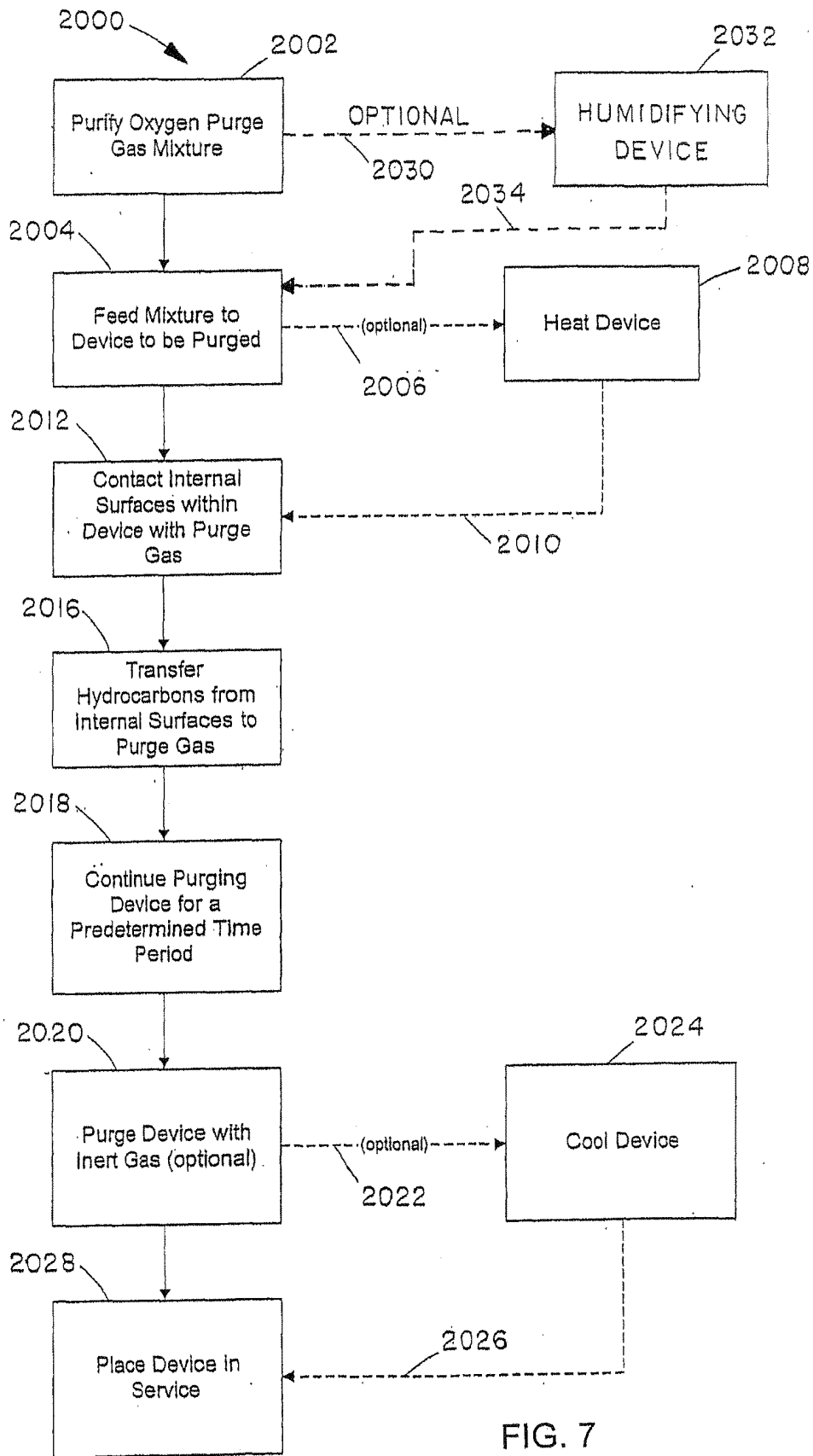
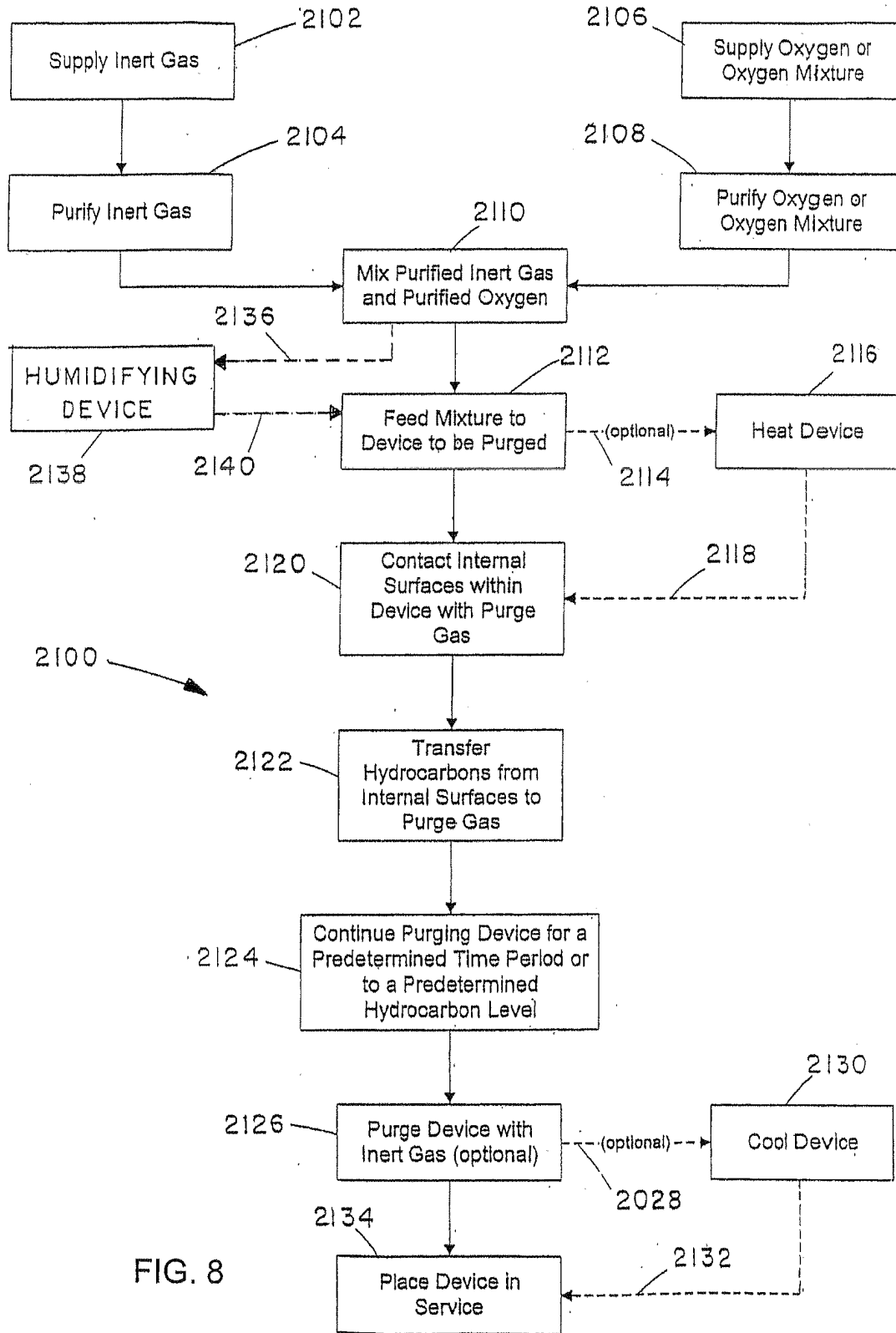

FIG. 7



8/29

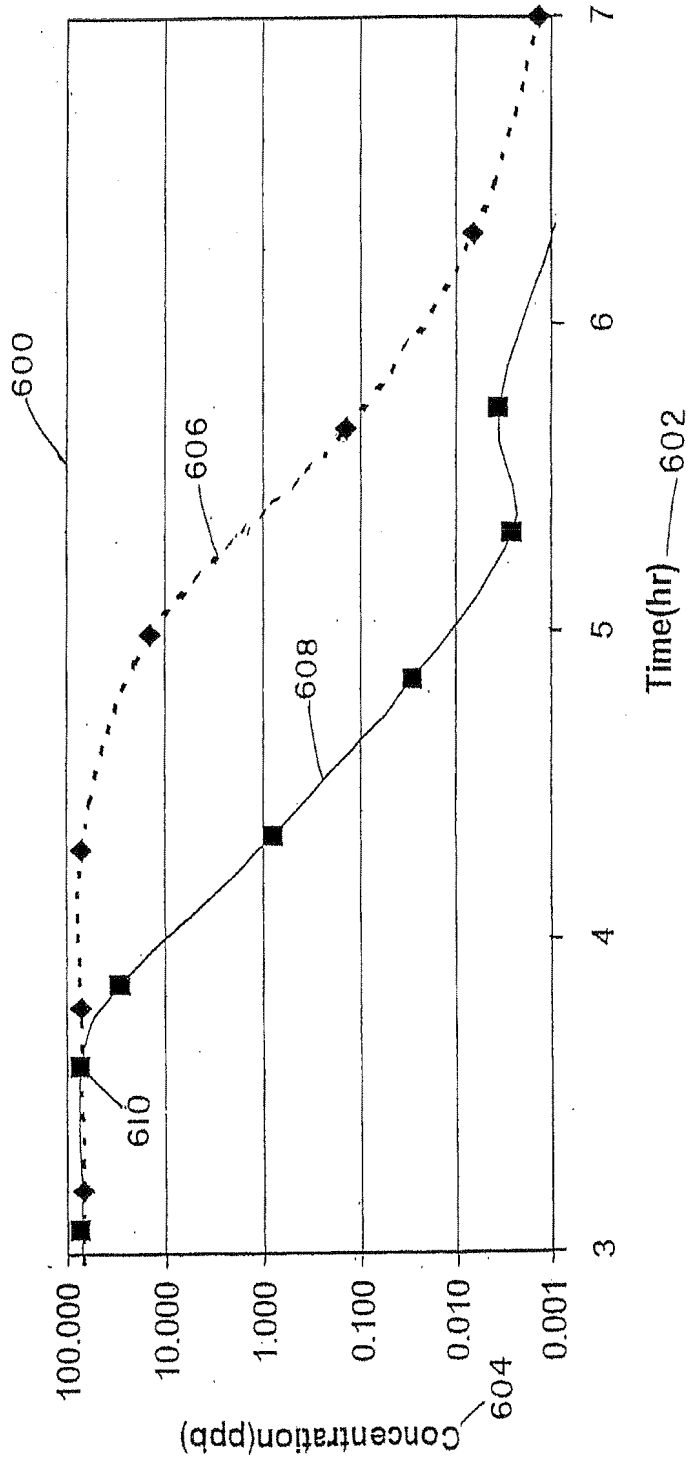

FIG. 9

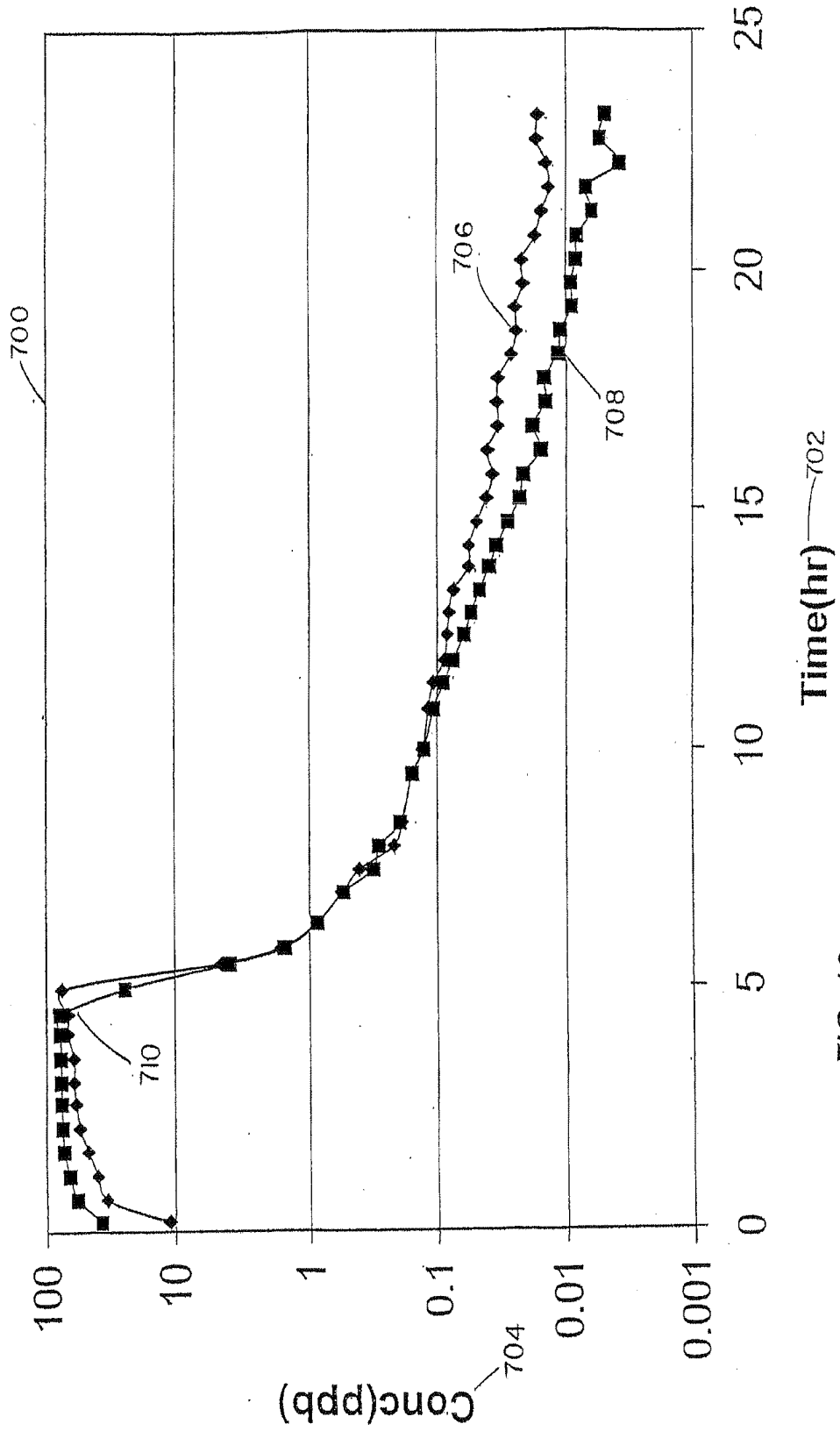

FIG. 10

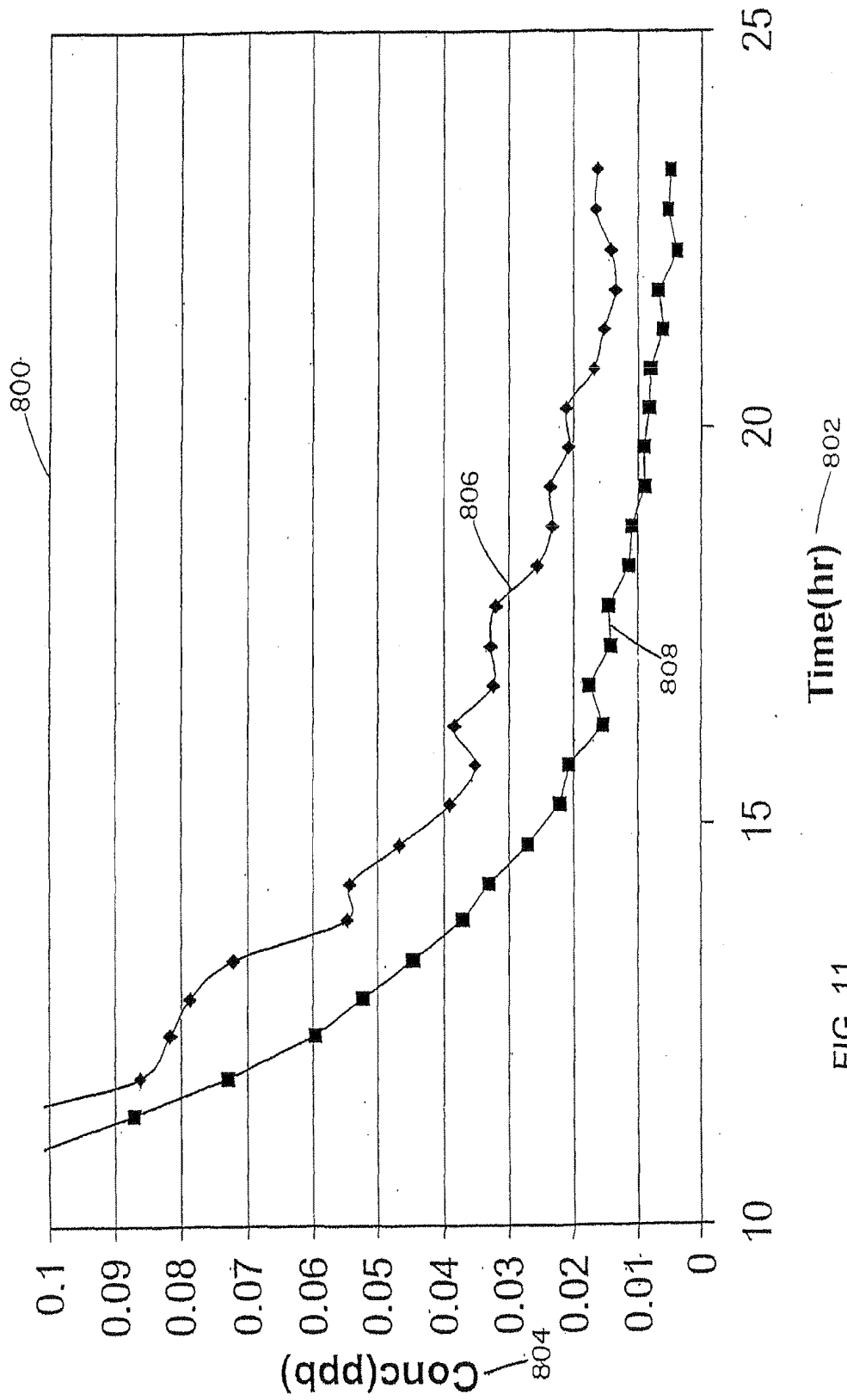

FIG. 11

11/29

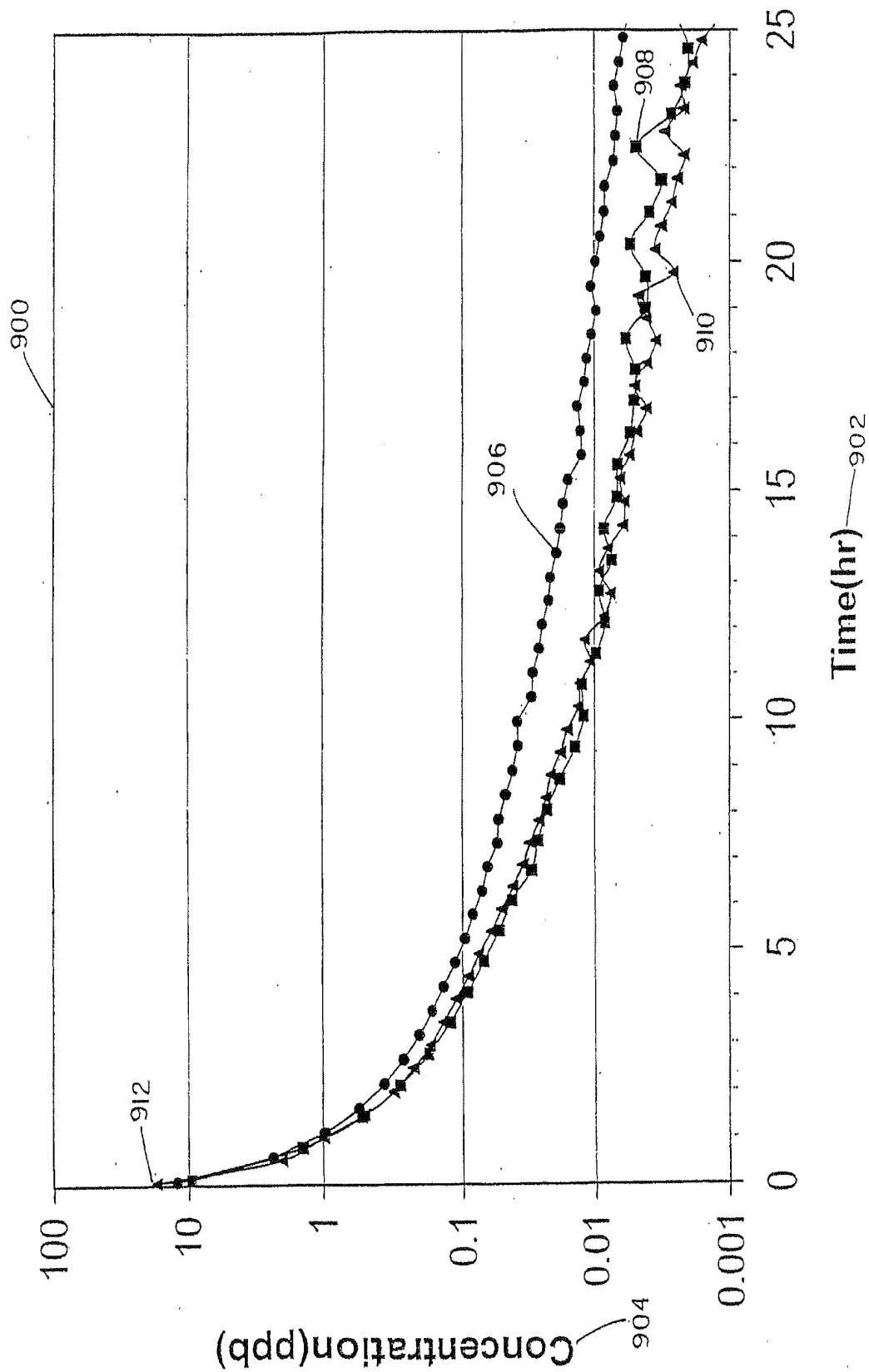

FIG. 12

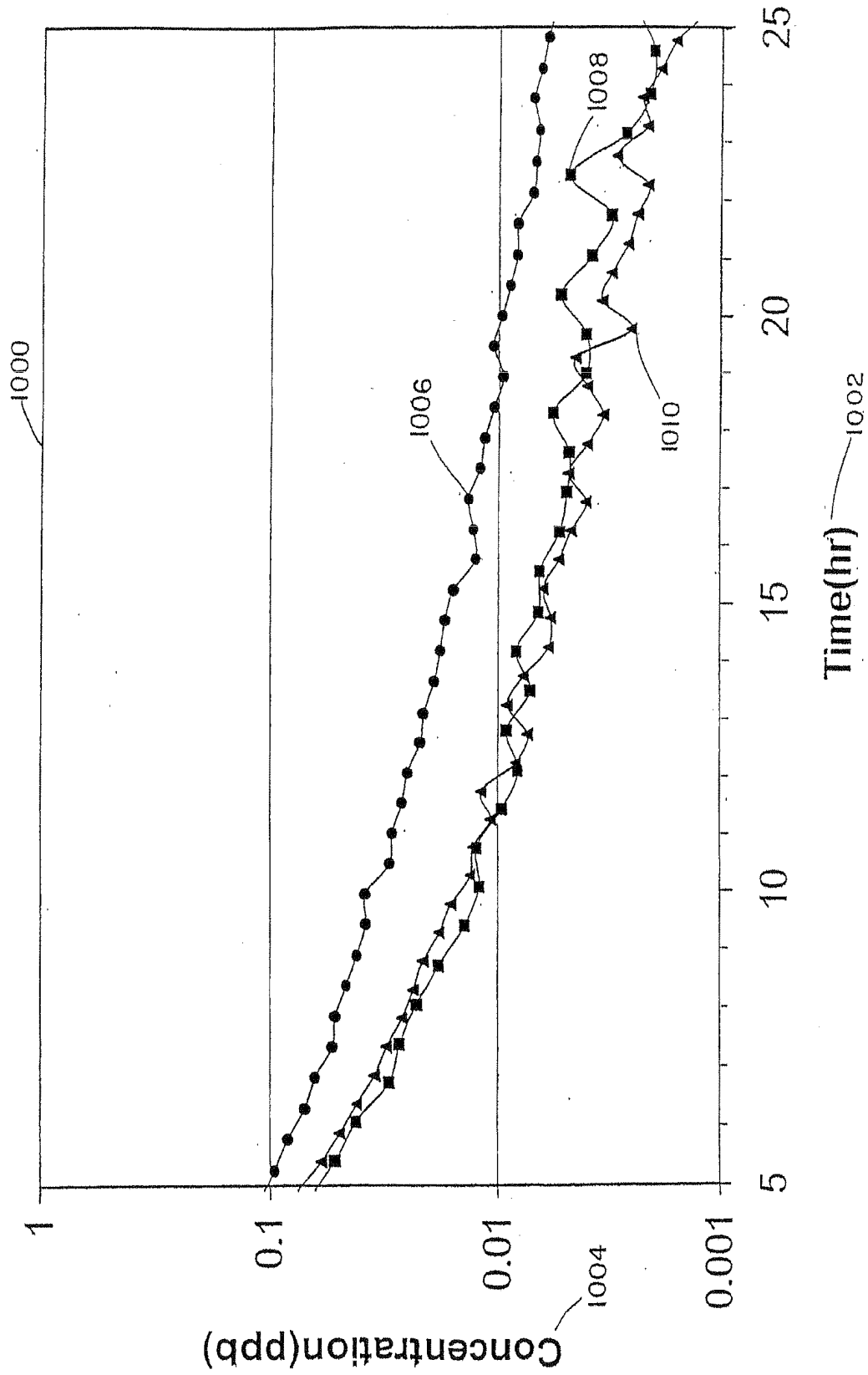

FIG. 13

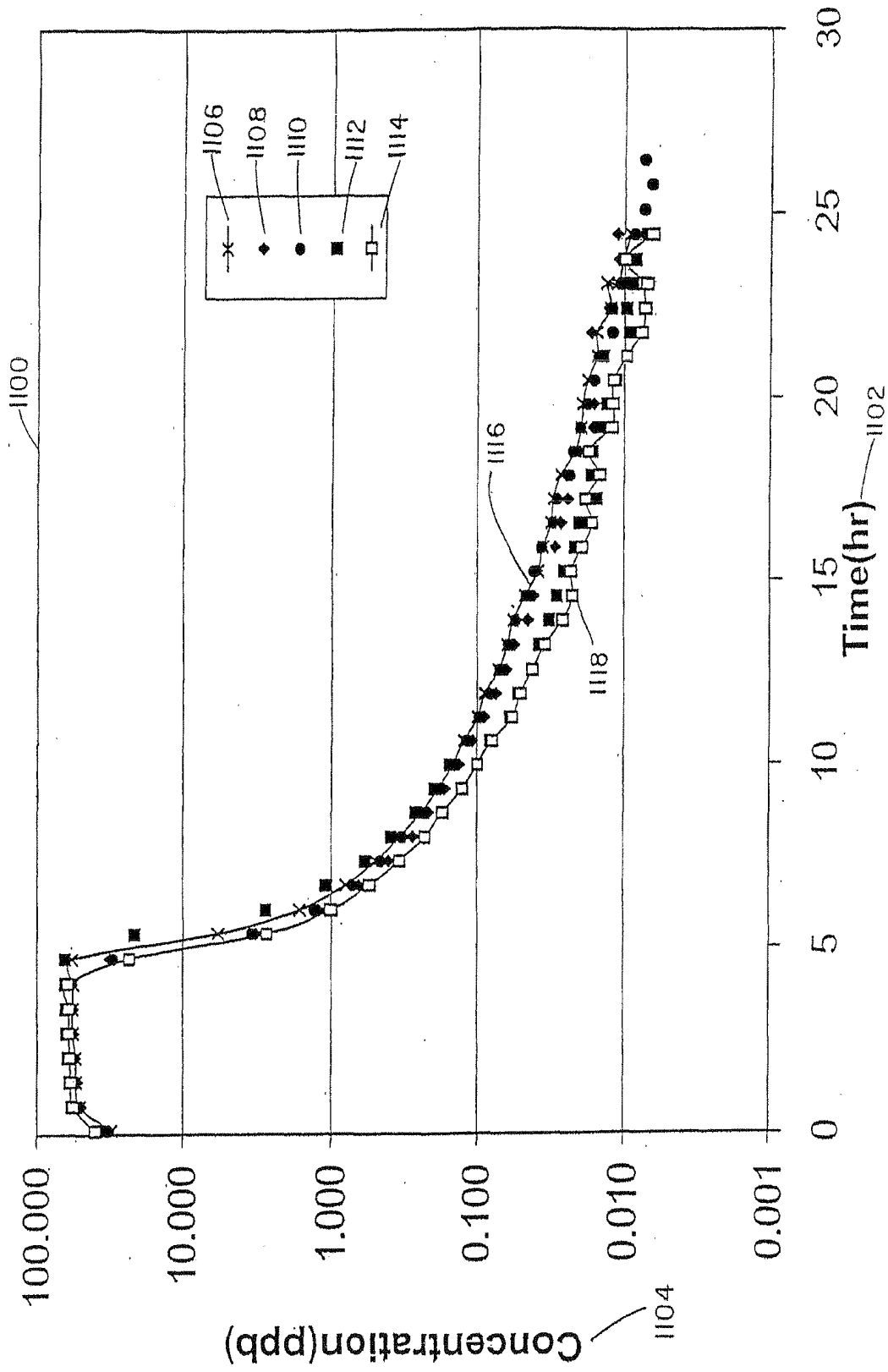

FIG. 14

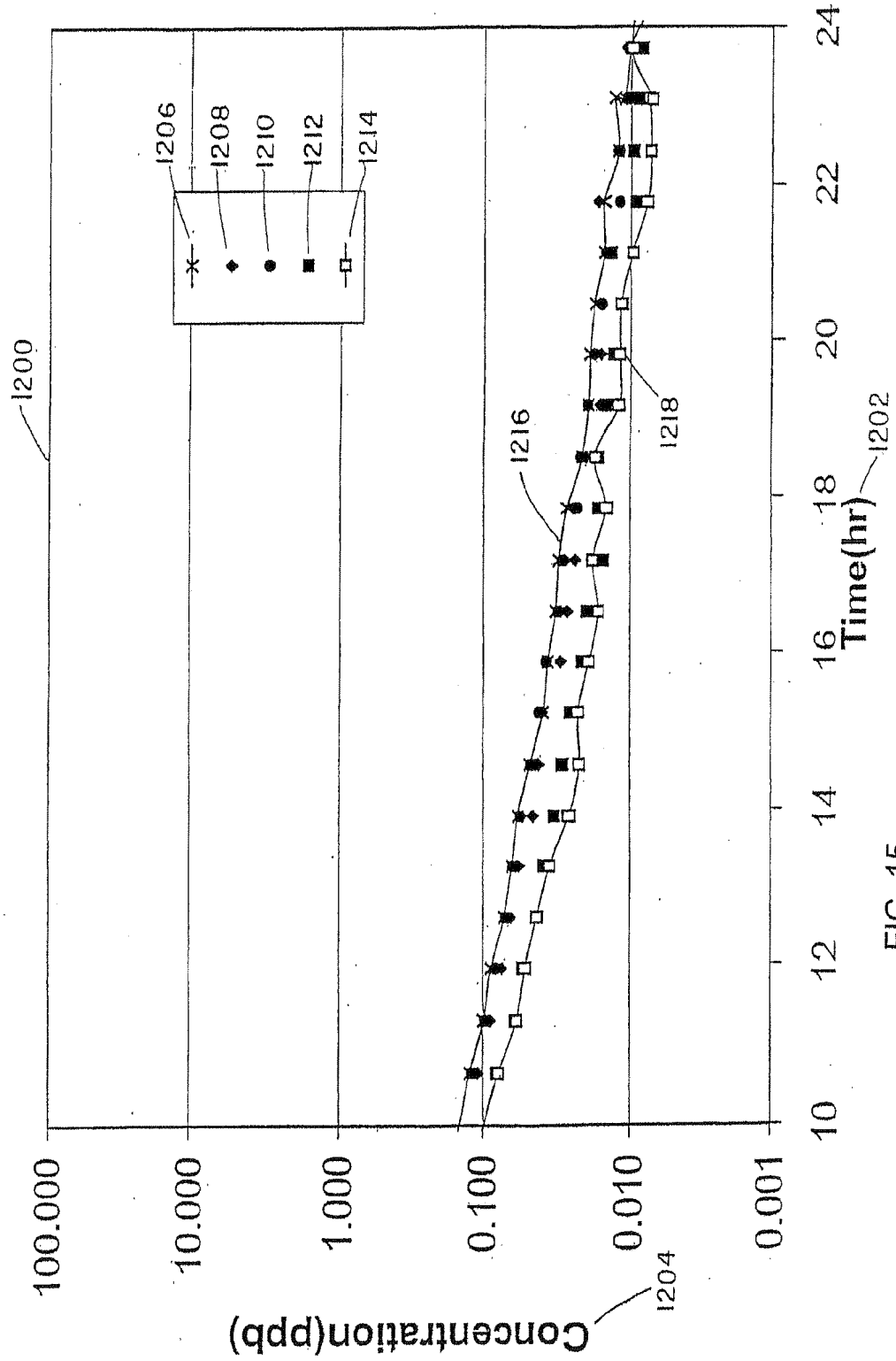

FIG. 15

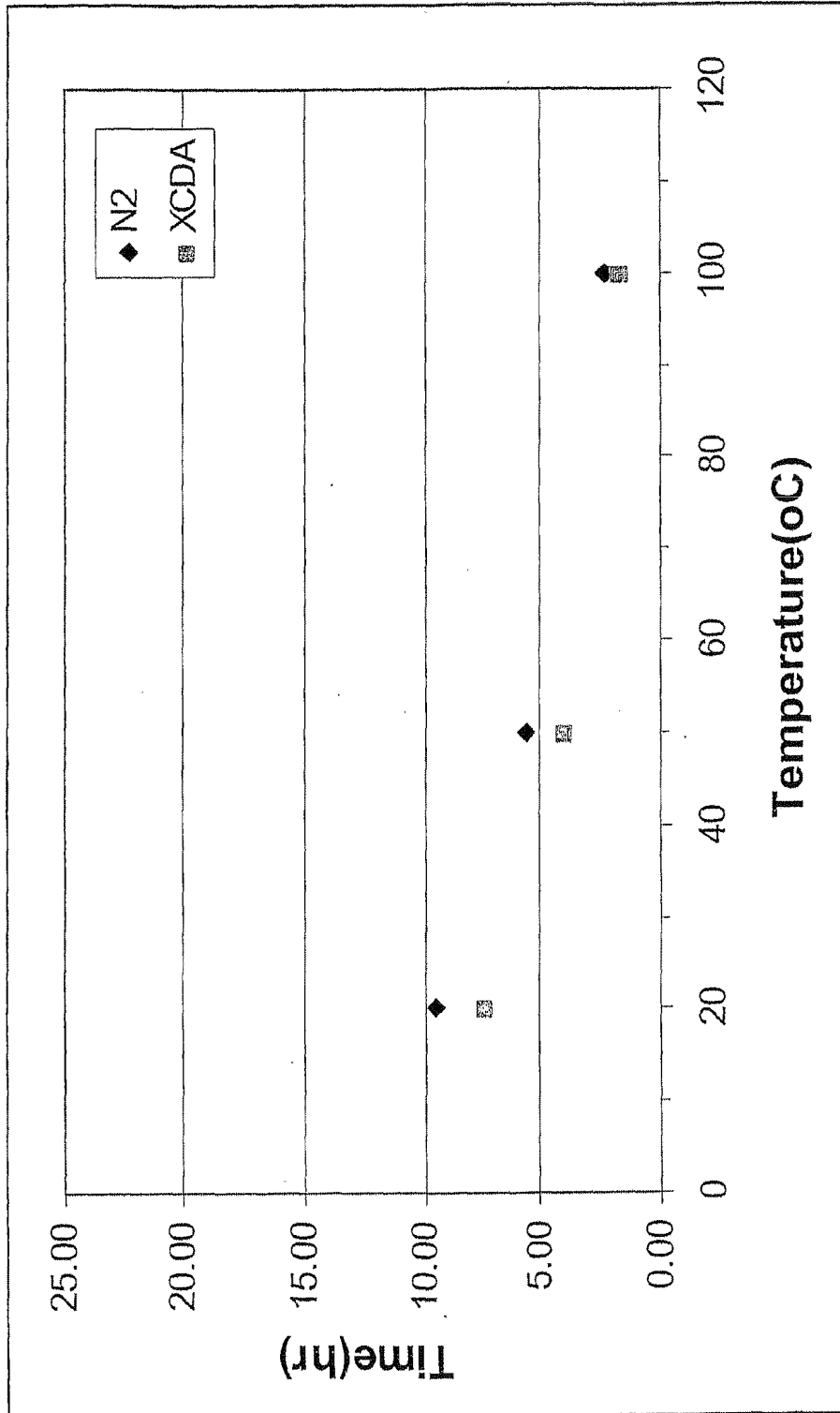

FIG. 16

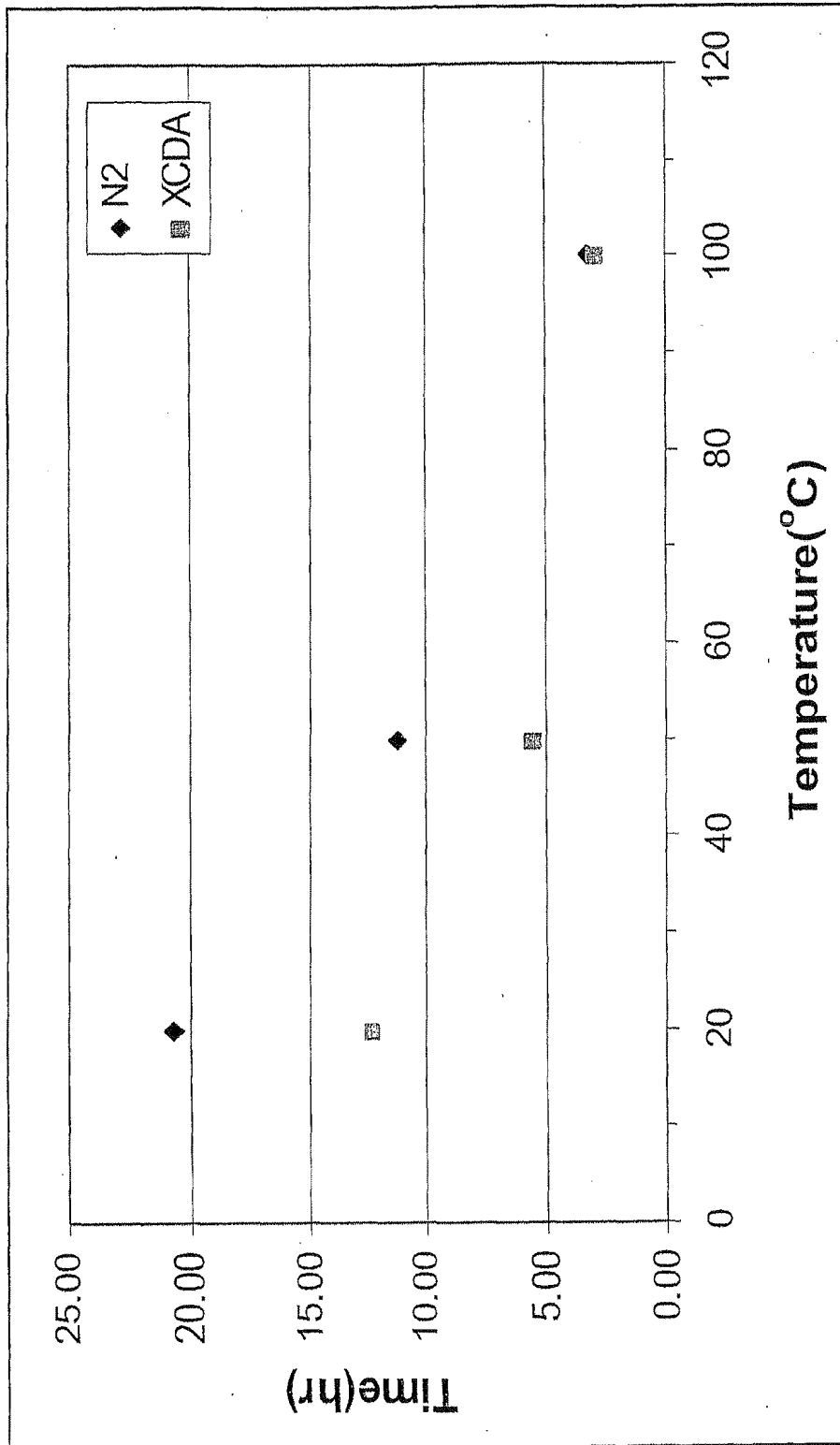

FIG. 17

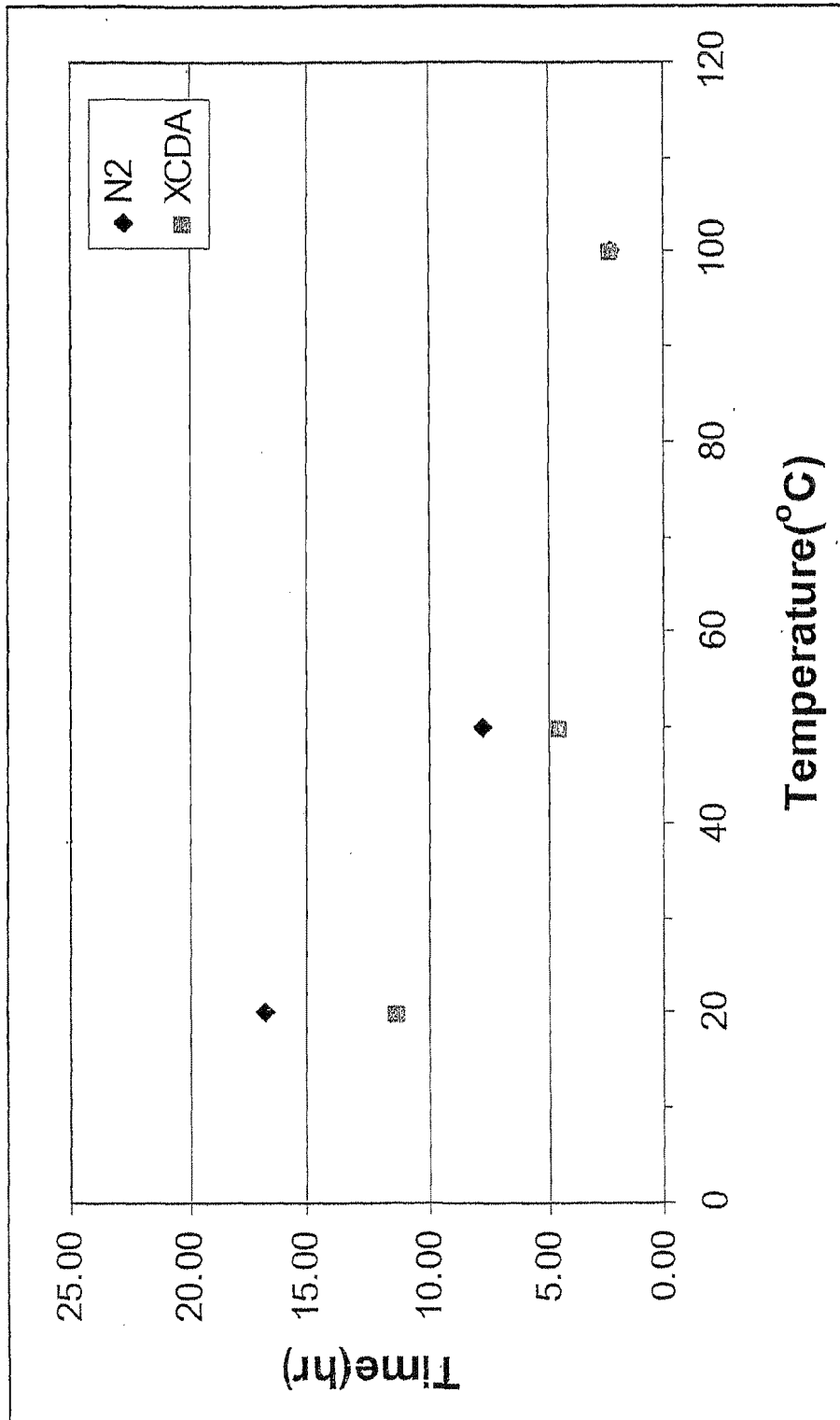

FIG. 18

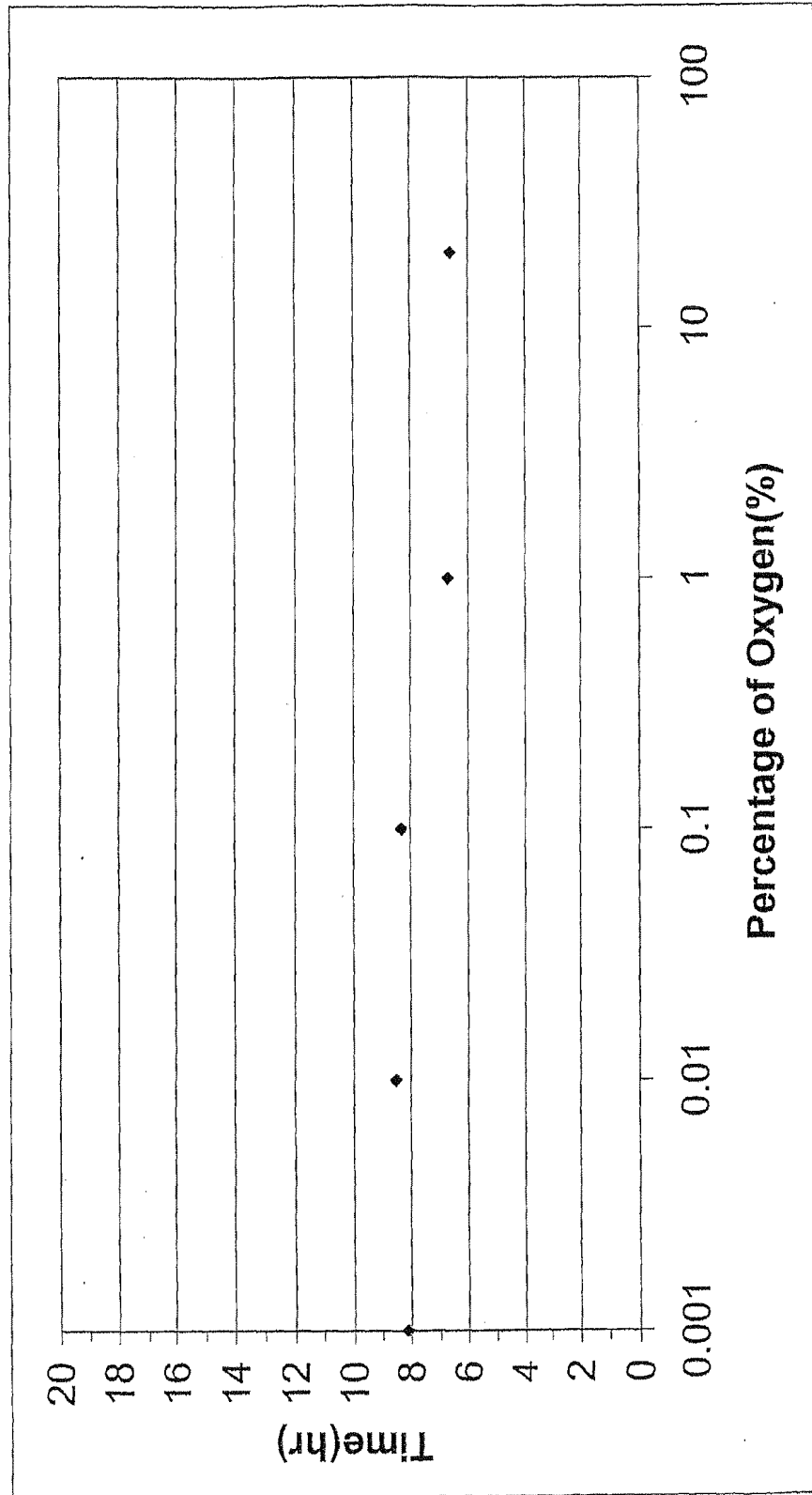

FIG. 19

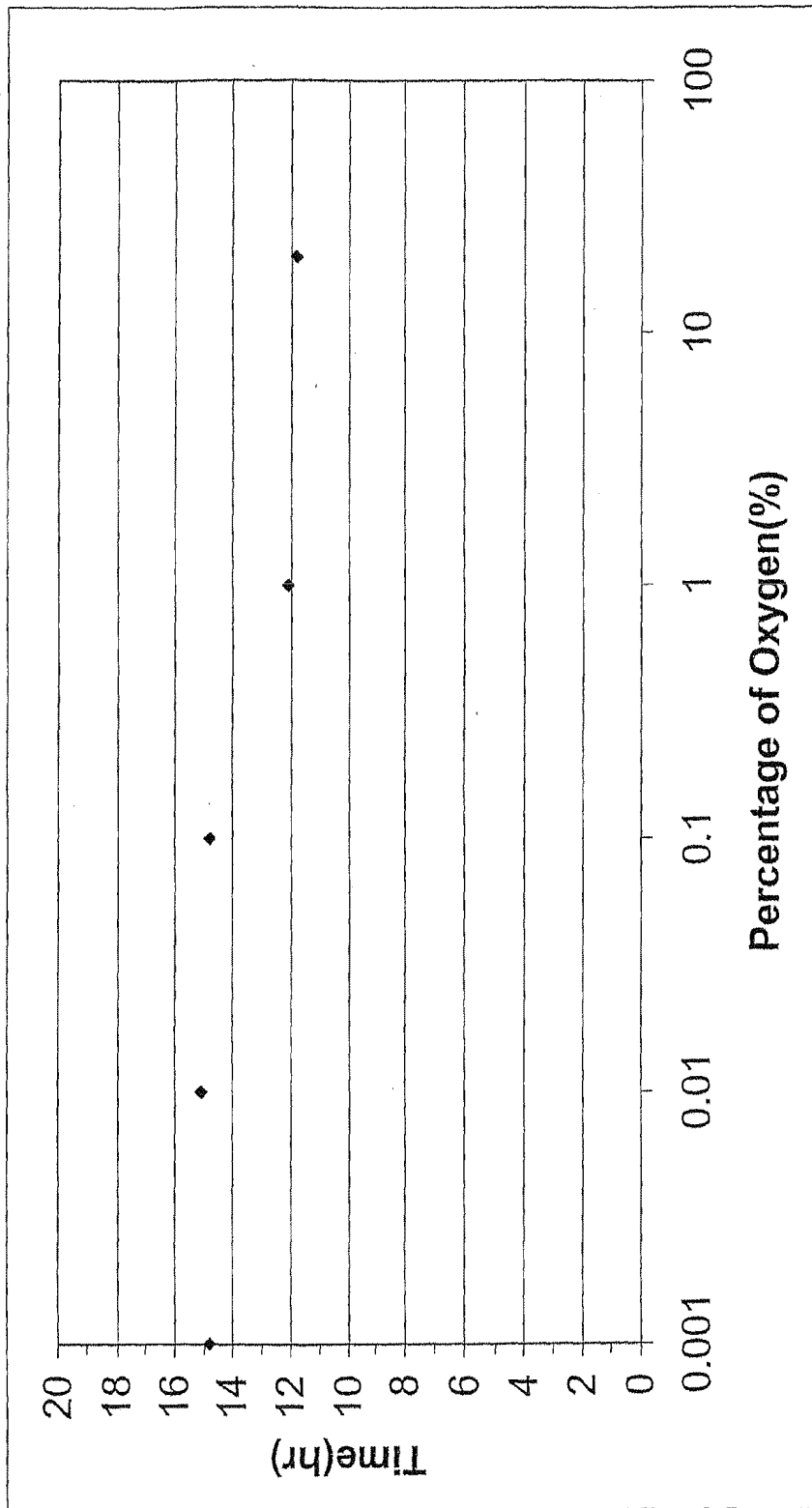

FIG. 20

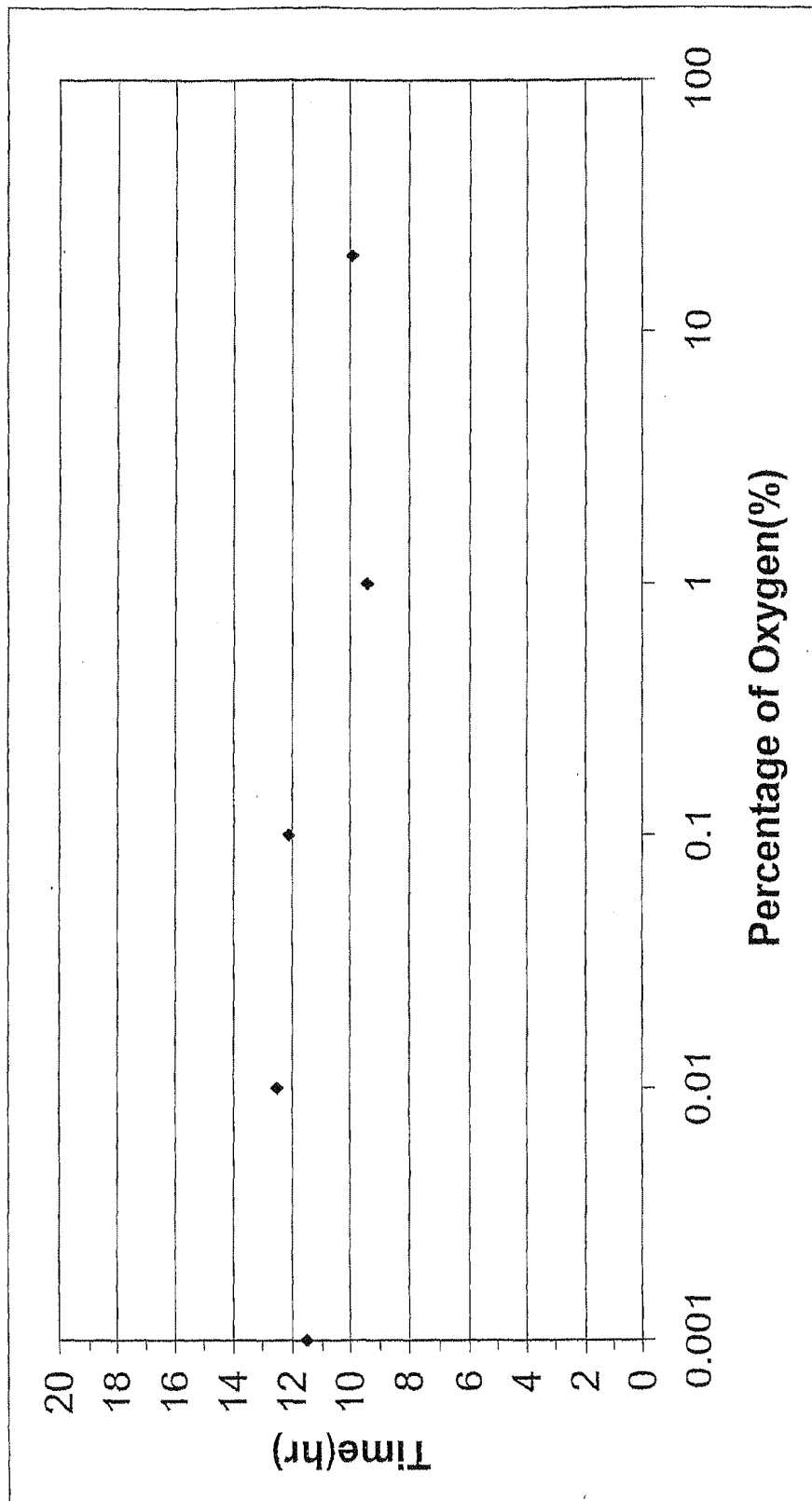

FIG. 21

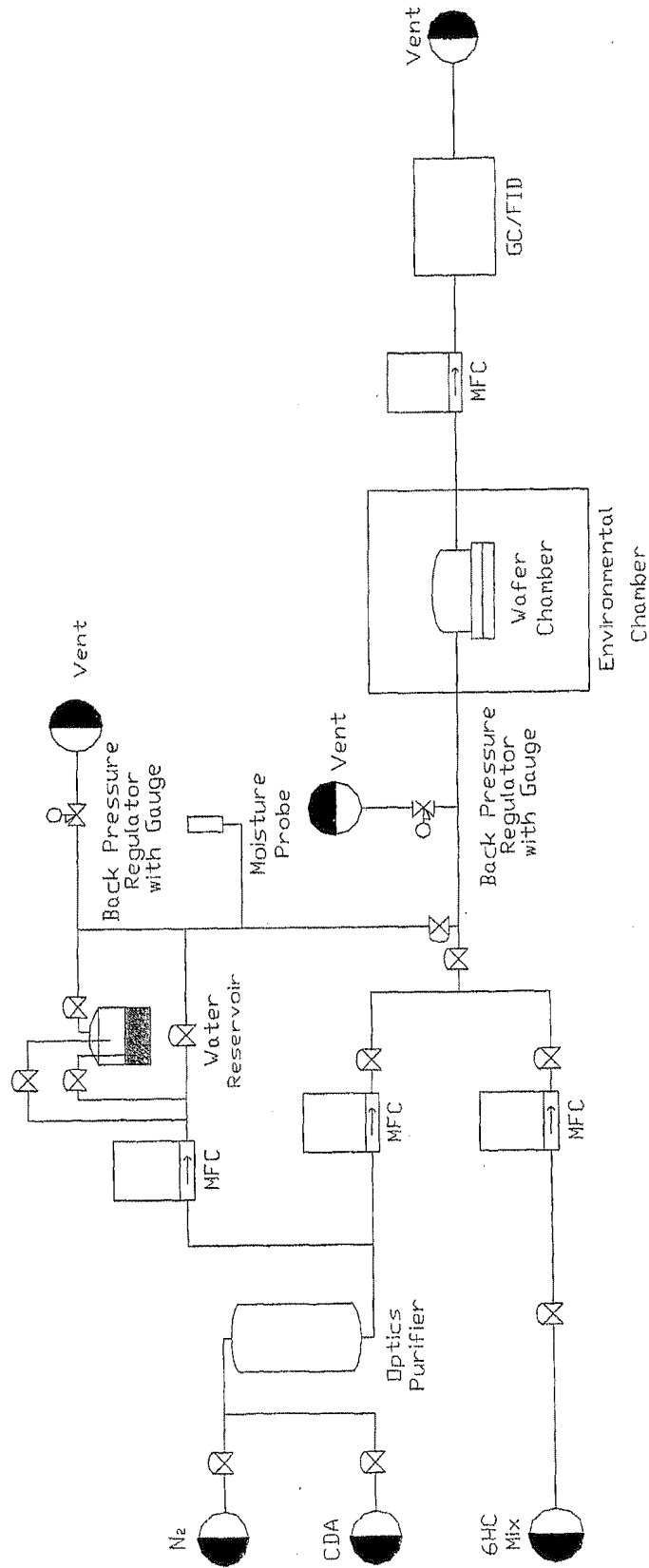

FIG. 22

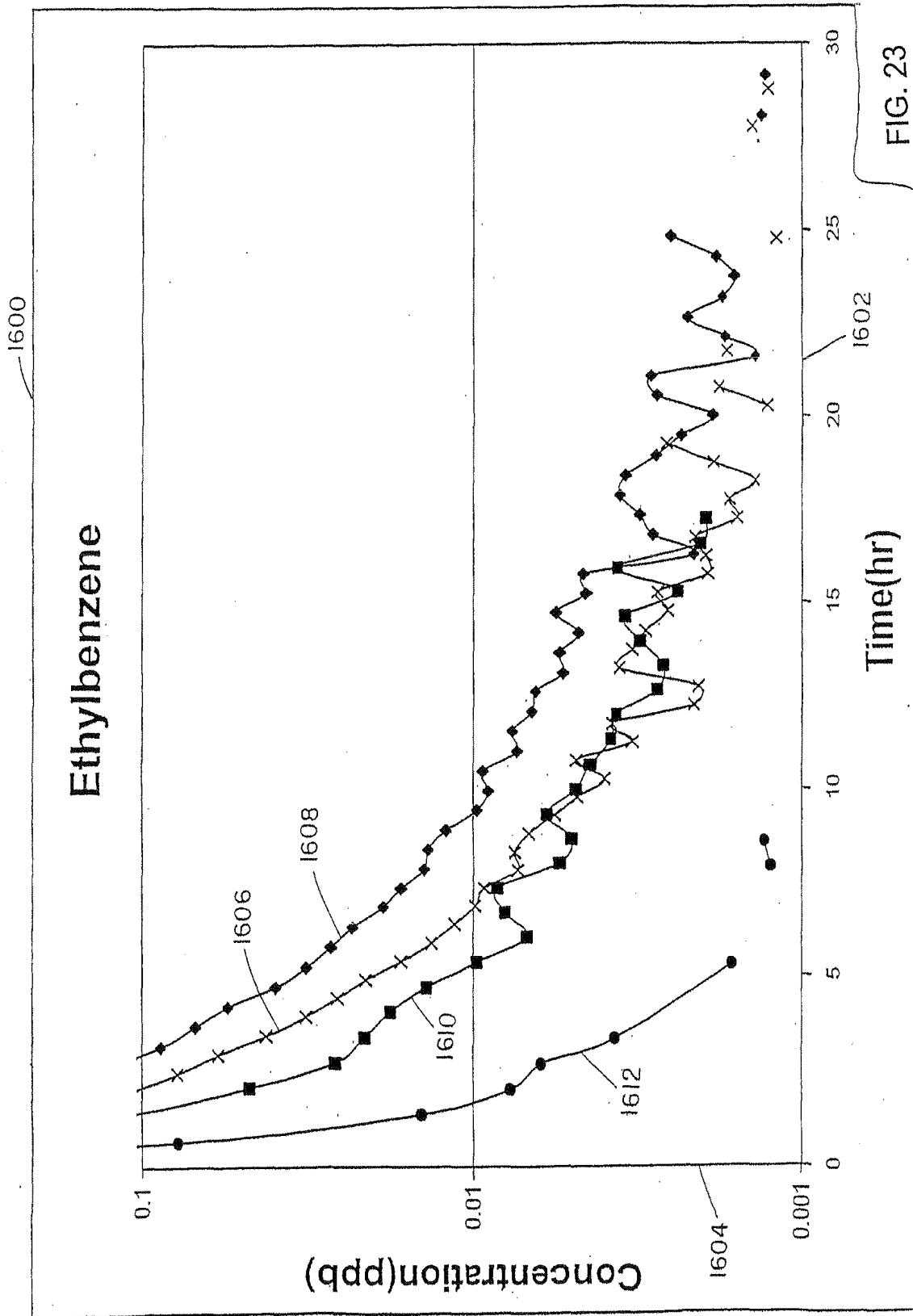

FIG. 23

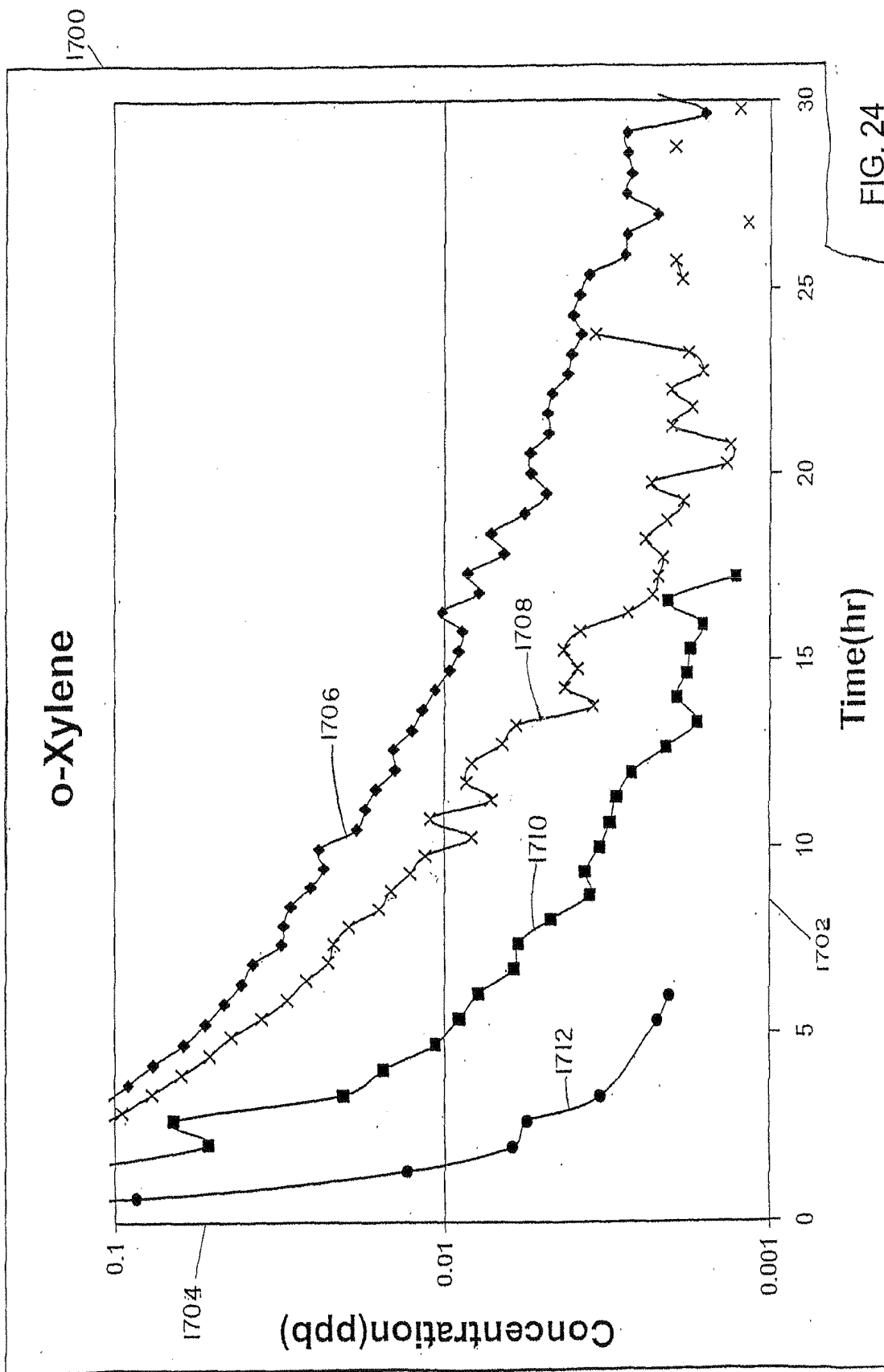

FIG. 24

24/29

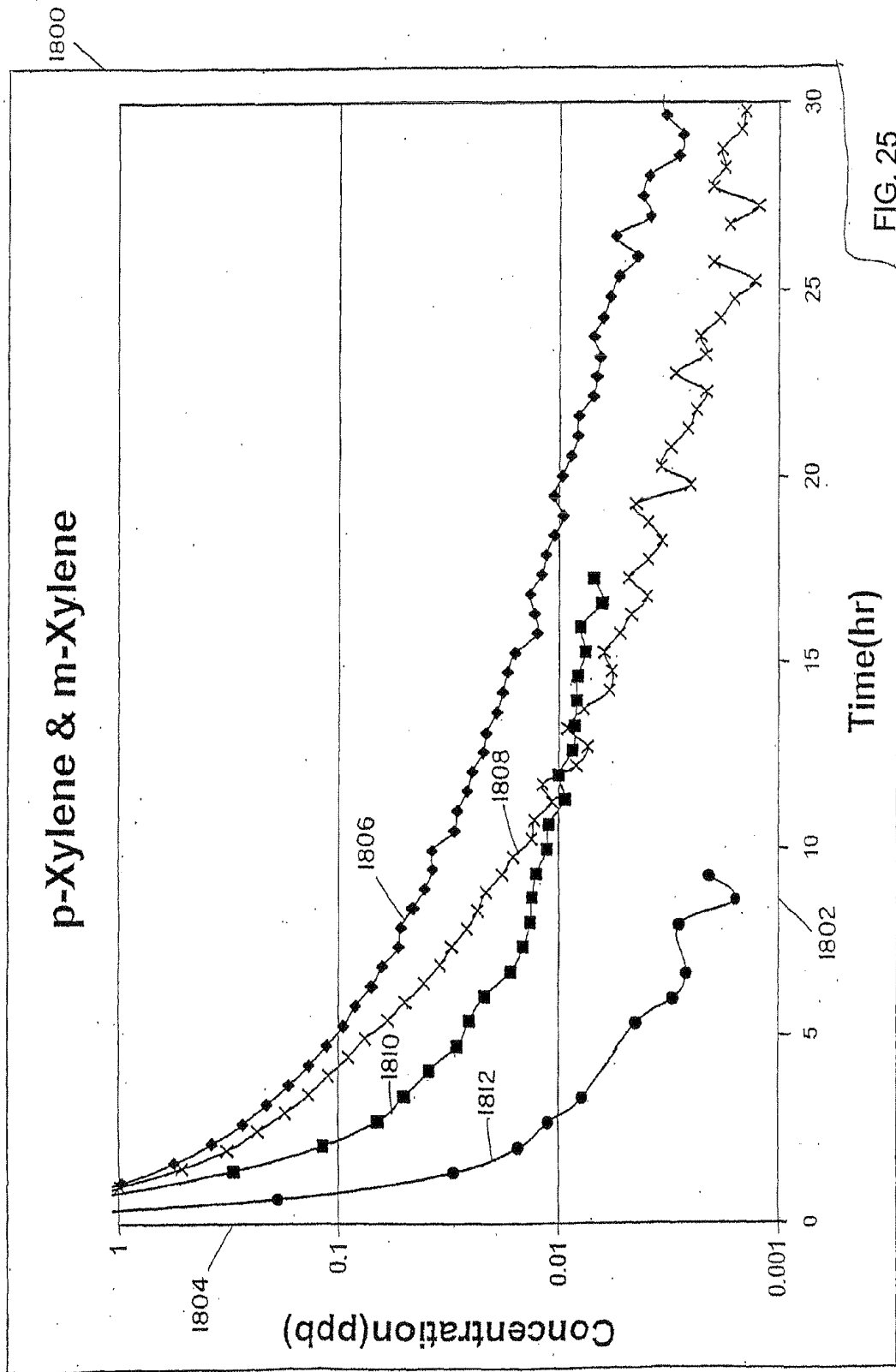

FIG. 25

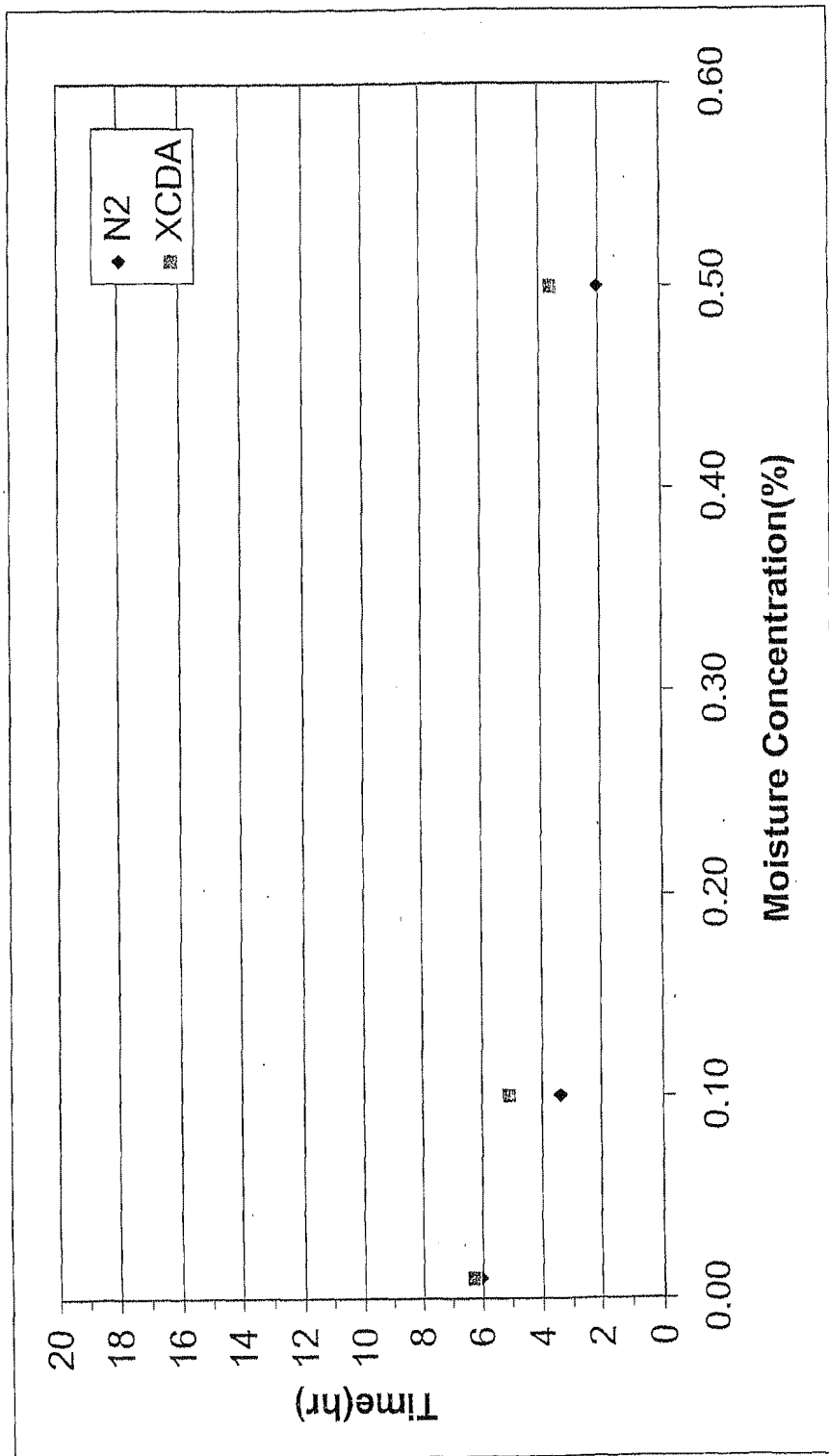

FIG. 26

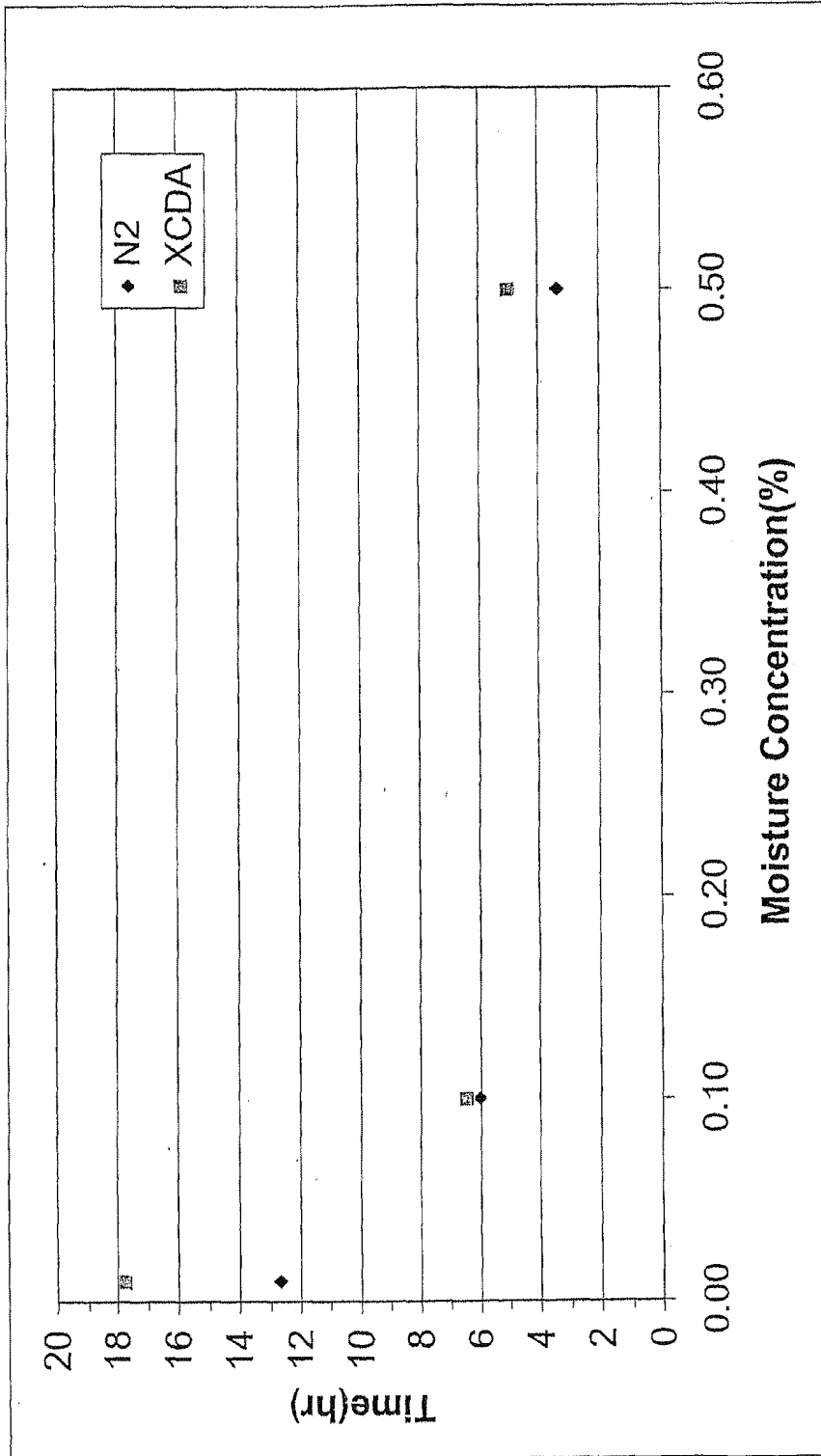

FIG. 27

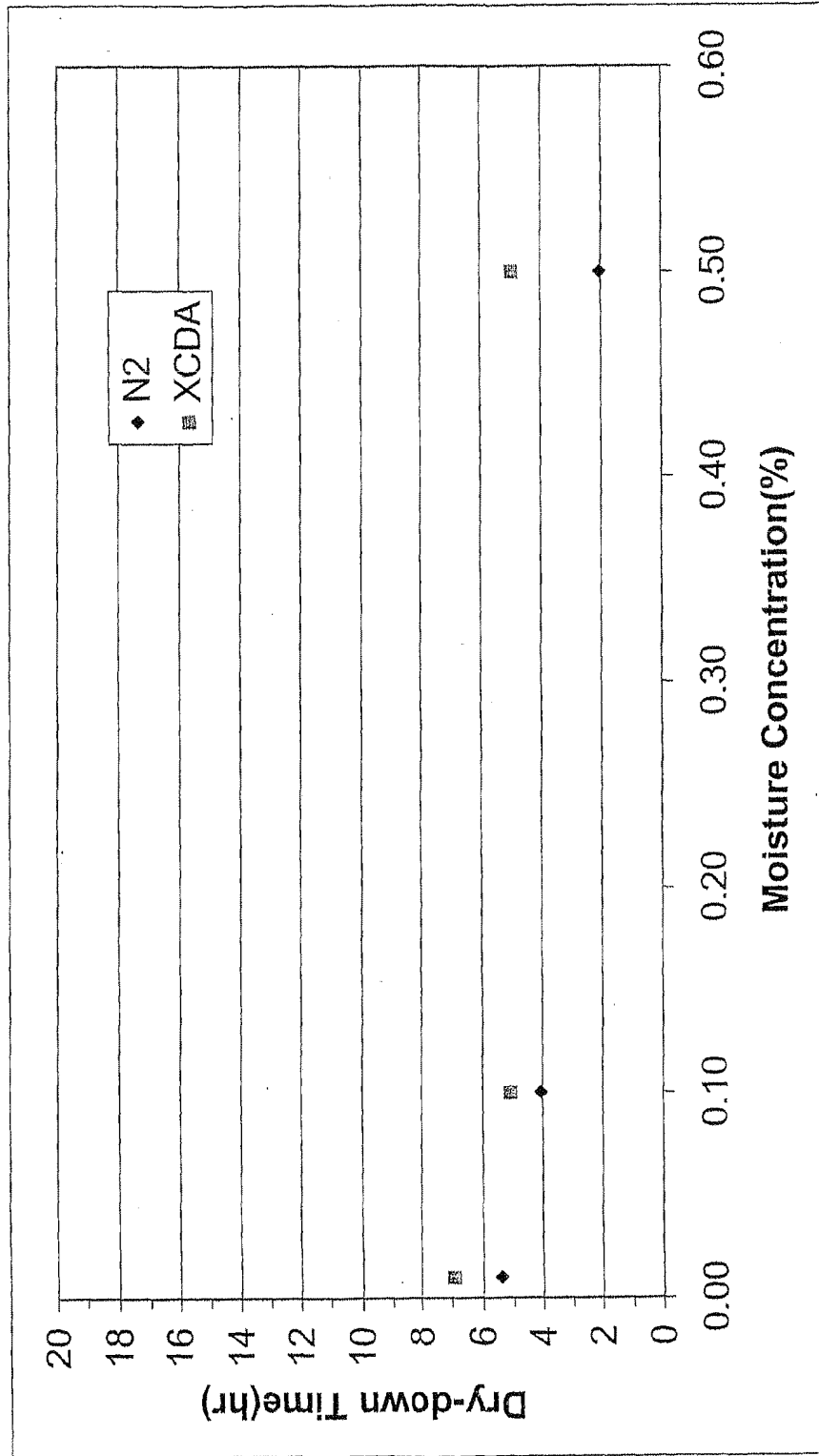

FIG. 28

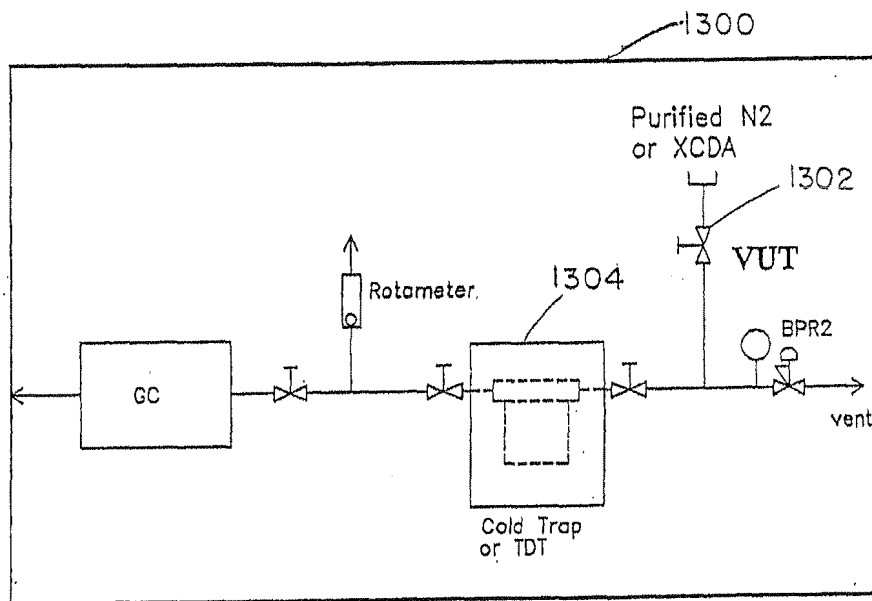

FIG. 29

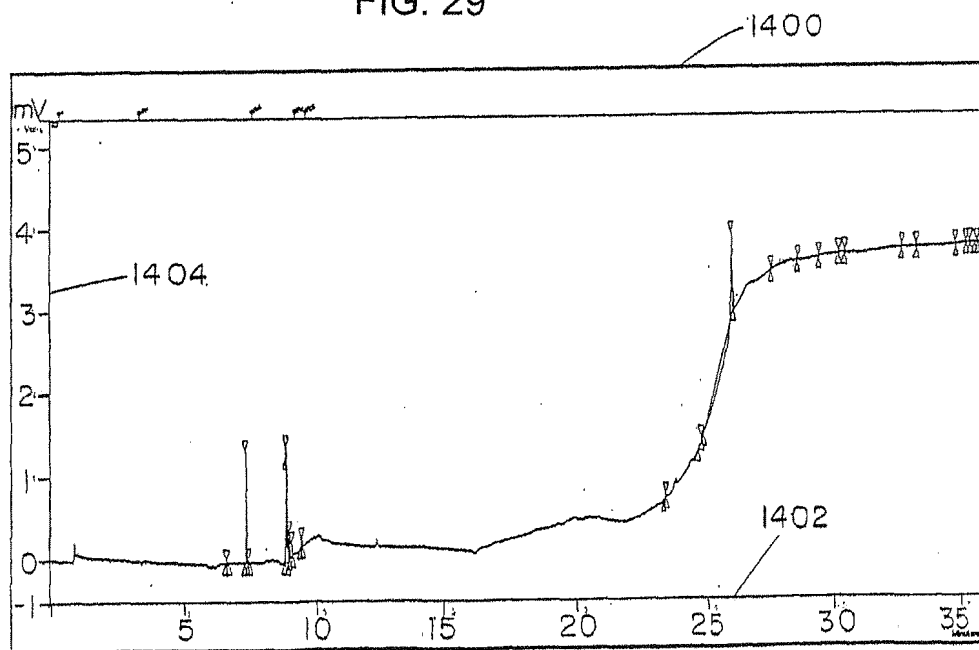

FIG. 30

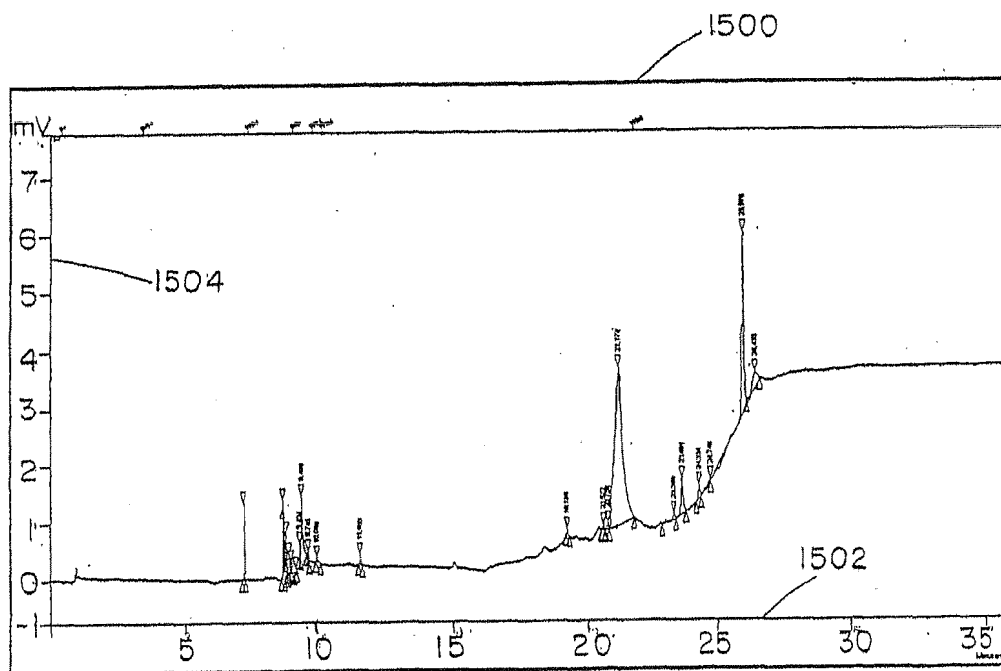

FIG. 31

INTERNATIONAL SEARCH REPORT

International Application No
/US2004/017251

A. CLASSIFICATION OF SUBJECT MATTER
 IPC 7 H01L21/306 B01D53/00 B01D53/72

According to International Patent Classification (IPC) or to both national classification and IPC

B. FIELDS SEARCHED

Minimum documentation searched (classification system followed by classification symbols)
 IPC 7 H01L B01D

Documentation searched other than minimum documentation to the extent that such documents are included in the fields searched

Electronic data base consulted during the international search (name of data base and, where practical, search terms used)
 EPO-Internal, WPI Data, PAJ

C. DOCUMENTS CONSIDERED TO BE RELEVANT		
Category *	Citation of document, with indication, where appropriate, of the relevant passages	Relevant to claim No.
X A A A A	WO 01/37329 A (LUCENT TECHNOLOGIES INC) 25 May 2001 (2001-05-25) page 4, lines 15,16; claims 1-9 ----- EP 0 867 924 A (IMEC INTER UNI MICRO ELECTR) 30 September 1998 (1998-09-30) claims 1-26 ----- US 2002/088478 A1 (DEGENDT STEFAN ET AL) 11 July 2002 (2002-07-11) claims 1-49 ----- DE 199 24 058 A (BOSCH GMBH ROBERT) 30 November 2000 (2000-11-30) claims 1-18 ----- <div style="text-align: center;">-/-</div>	1 2-35 1-35 1-35 1-35

Further documents are listed in the continuation of box C. Patent family members are listed in annex.

* Special categories of cited documents:

<p>*A* document defining the general state of the art which is not considered to be of particular relevance</p> <p>*E* earlier document but published on or after the international filing date</p> <p>*L* document which may throw doubts on priority claim(s) or which is cited to establish the publication date of another citation or other special reason (as specified)</p> <p>*O* document referring to an oral disclosure, use, exhibition or other means</p> <p>*P* document published prior to the international filing date but later than the priority date claimed</p>	<p>*T* later document published after the international filing date or priority date and not in conflict with the application but cited to understand the principle or theory underlying the invention</p> <p>*X* document of particular relevance; the claimed invention cannot be considered novel or cannot be considered to involve an inventive step when the document is taken alone</p> <p>*Y* document of particular relevance; the claimed invention cannot be considered to involve an inventive step when the document is combined with one or more other such documents, such combination being obvious to a person skilled in the art.</p> <p>*Z* document member of the same patent family</p>
--	--

Date of the actual completion of the international search	Date of mailing of the international search report
28 October 2004	09/11/2004

Name and mailing address of the ISA European Patent Office, P.B. 5818 Patentlaan 2 NL - 2280 HV Rijswijk Tel. (+31-70) 340-2040, Tx. 31 651 epo nl, Fax: (+31-70) 340-3016	Authorized officer <div style="text-align: center;">Kanoldt, W</div>
--	---

INTERNATIONAL SEARCH REPORT

International Application No
/US2004/017251

C.(Continuation) DOCUMENTS CONSIDERED TO BE RELEVANT		
Category *	Citation of document, with indication, where appropriate, of the relevant passages	Relevant to claim No.
A	US 6 124 211 A (BUTTERBAUGH JEFFERY W ET AL) 26 September 2000 (2000-09-26) claims 1-21; example 12 -----	1-35
A	US 5 938 854 A (ROTH JOHN REECE) 17 August 1999 (1999-08-17) claims 1-49 -----	1-35
A	US 5 230 721 A (OHMI TADAHIYO) 27 July 1993 (1993-07-27) claims 1-7 -----	1-35

INTERNATIONAL SEARCH REPORT

Information on patent family members

International Application No

/US2004/017251

Patent document cited in search report	Publication date	Patent family member(s)	Publication date
WO 0137329	A	25-05-2001	AU 1604501 A 30-05-2001
			WO 0137329 A1 25-05-2001
			US 6588437 B1 08-07-2003
EP 0867924	A	30-09-1998	EP 0867924 A2 30-09-1998
			US 2002088478 A1 11-07-2002
			US 6551409 B1 22-04-2003
			US 2002011257 A1 31-01-2002
			JP 11219926 A 10-08-1999
US 2002088478	A1	11-07-2002	US 2002130106 A1 19-09-2002
			US 6551409 B1 22-04-2003
			US 2001042559 A1 22-11-2001
			US 2002011257 A1 31-01-2002
			EP 0867924 A2 30-09-1998
			JP 11219926 A 10-08-1999
DE 19924058	A	30-11-2000	DE 19924058 A1 30-11-2000
US 6124211	A	26-09-2000	EP 0801606 A1 22-10-1997
			JP 10513612 T 22-12-1998
			WO 9713646 A1 17-04-1997
			EP 0688045 A1 20-12-1995
			JP 8064559 A 08-03-1996
			US 5534107 A 09-07-1996
			US 5580421 A 03-12-1996
			US 5716495 A 10-02-1998
			US 6015503 A 18-01-2000
			US 5938854
US 5669583 A 23-09-1997			
AU 695099 B2 06-08-1998			
AU 6148496 A 18-12-1996			
CA 2222620 A1 05-12-1996			
EP 0828618 A1 18-03-1998			
JP 11507990 T 13-07-1999			
WO 9638311 A1 05-12-1996			
AU 679237 B2 26-06-1997			
AU 6962394 A 20-12-1994			
CA 2163967 A1 08-12-1994			
EP 0700577 A1 13-03-1996			
JP 8511898 T 10-12-1996			
RU 2154363 C2 10-08-2000			
WO 9428568 A1 08-12-1994			
US 5403453 A 04-04-1995			
US 6146724 A 14-11-2000			
US 5230721	A	27-07-1993	JP 63014414 A 21-01-1988